

**STRAT)-(MORE**

SANTA GERTRUDIS

*Bulls you can Bank on*

21st Annual

# Bull Sale

1:30pm - Tuesday 19th October 2021

[strathmoresg.com.au](http://strathmoresg.com.au)



The Walker Family cordially invites you to the

# STRAT)-(MORE

SANTA GERTRUDIS

21st Annual

## On-Property Bull Sale

**'Ravensbourne' Blackall**

1:30pm - Tuesday 19th October 2021

Offering by Public Auction:

**130 PUREBRED SANTA GERTRUDIS BULLS**

**83 Classified Bulls**

**47 Herd Bulls**

### SELLING AGENT

*Elders*

Blackall Branch  
Nick Handley  
P 07 4657 4466  
M 0428 581 001

### CONTACT

Ian, Andrew and Ben Walker  
'Ravensbourne' Blackall  
Ian: 0427 575 963  
Andrew: 0427 576 031  
Ben: 0428 575 082  
E: ravensbourne@bigpond.com  
E: b\_cwalker@bigpond.com  
www.strathmoresg.com.au

  
**AuctionsPlus**<sup>®</sup>  
Australia's Livestock Marketplace

Like us on Facebook

 @strathmoresg

Follow us on Instagram

 strathmore\_santa\_gertrudis

## Bull Information

> Vaccinations - 3 Germ Blood, 3-Day, Botulism and Vibrio

> Breeding Soundness Guaranteed

> Semen Morphology Figures

> Weights and Daily Weight Gains

> Eye Muscle Area Measurements

> Rib Fat and Rump Fat Measurements

> Scrotum Measurements

> All Bulls J-BAS 7

## Inspection Welcome prior to Sale

### CONTACT

**Ian Walker**

**P** 0427 575 963

**E** ravensbourne@bigpond.com

**Ben Walker**

**P** 0428 575 082

**E** b\_cwalker@bigpond.com



## Sale Information

'Ravensbourne' Station, Blackall  
60 Kilometres SSW of Blackall  
on the Ravensbourne Road

### REFRESHMENTS AND LUNCH

Made available by members of Blackall Branch of ICPA.

### SALE DAY PHONE NUMBERS

0429 936 110 | 0427 575 963 | 0428 575 082

### PRE-SALE INSPECTION

Inspections are welcome at Ravensbourne any time leading up to the sale. Appointment may be arranged by contacting selling agents or the vendors at Ravensbourne; phone 0428 575 082 or 0427 575 963.

### AIRSTRIPE

Ravensbourne Qld. WAC 3341 Var 8 degrees, E 24 degrees, 50' S 145 degrees, 36' E. Sandstone runway N/S 1000m. Strip is adjacent to HS. Telstra Tower 10km SW. Windsock 400m from south end.

Further details contact **Ian Walker** on **0427 575 963**

### ACCOMMODATION

Blackall Motel	(07) 4657 4611
Coolibah Motel, Blackall	(07) 4657 4380
Blackall Caravan Park	(07) 4657 4816
The Barcoo Hotel, Blackall	(07) 4657 4197
The Tambo Mill Motel and Caravan Park	(07) 4654 6100
The Tambo Tavern	(07) 4654 6109

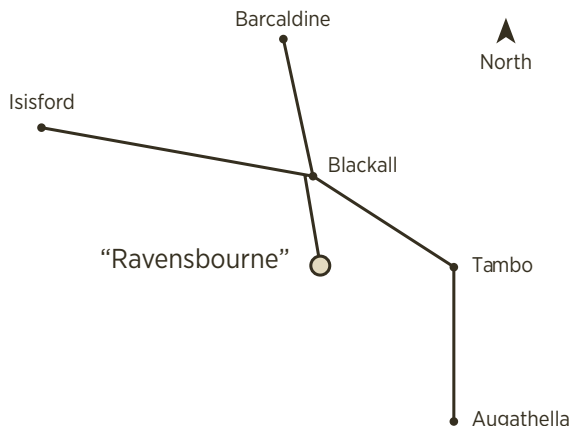

## Notice to Buyers

**HEALTH** - All bulls have been vaccinated for 3-Day, Botulism and Vibrio. They have also been injected with 3 Germ Blood. The herd is TB and Brucellosis free. All Bulls J-BAS 7.

**MEASUREMENTS** - Fat scans, eye muscle area, scrotal size, weight and daily weight gain information will be supplied on the day of sale on supplementary sheets.

**INSTRUCTIONS** - All instructions covering delivery of cattle purchased at this sale must be given in writing and signed by buyer or his representative. A tear-off Instruction Sheet is provided for this purpose at the back of the catalogue.

**DELIVERY** - Delivery will be given at Ravensbourne on the day of the sale. If needed, bulls will be delivered to Blackall. Cattle awaiting trucking will be held free of charge for a period not exceeding two weeks. Every care will be taken but absolutely no responsibility will be accepted.

**INSURANCE** - Insurance representatives will be in attendance at the sale and will insure your purchases on the fall of the hammer if required.

**REBATE** - Vendor will allow 3% rebate to outside agents introducing buyers in writing 24 hours prior to the sale and settling on their behalf by 2nd November 2021.

### Important Notice

All livestock will be sold under the Queensland Livestock Agents Association Limited Standard Stud Stock - Auction Terms and Conditions of Sale that will be displayed on the day of the sale. All persons who attend the sale do so entirely at their risk and Strathmore Santa Gertrudis Stud, the Selling Agents, its members, subsidiary or related corporations, officers, agents, employees and its principals, for themselves and for those for whom they act, do not assume or accept any responsibility or liability of whatever nature for any injury or damage whatsoever, which may occur.

## Semen Morphology

Semen Morphology is the count expressed as a percentage (by an accredited Semen Morphologist) of the normal sperm in an ejaculate from a bull. Some types of abnormal sperm are unable to fertilise the egg while other types of abnormal sperm can fertilise the egg but then cause the resulting embryo to die. It is therefore likely that a sexually active bull with a high percentage of normal sperm will be more fertile than one with a low percentage of normal sperm.

Crush side semen testing without the examination of Semen Morphology is unreliable and incomplete.

The Bull Power Project found that semen quality particularly the percentage of normal sperm was consistently related to a high number of calves on the ground and a more compressed calving.

While a pass for Semen Morphology does not guarantee high fertility, continued failure almost certainly means relatively low fertilisation rates. By retesting the bulls that fail the initial test, our aim is to identify those animals that have a genetic weakness or a predisposition to be affected by outside factors. We place great emphasis on this comprehensive semen analysis and all Strathmore bulls sold must pass The Australian Cattle Veterinary Thresholds for specific and total abnormalities. Bulls that fail are removed from sale.

Test results are subject to change and are affected by sexual maturity, nutrition, to the rate of weight gain or loss, age, genetics, injury, illness, relocation and environmental stresses.

Bulls with results from 70%-100% normal sperm are deemed fertile for single sire mating. Bulls with 50%-69% are deemed as acceptable for multiple sire mating. The total percentage results for all bulls will be stated on the supplementary sheets on the day of Sale.

Accredited Semen Morphologists used:

**Kellie Prosser**

**Accreditation No. - SMA0709**

# COVID-19

The health and wellbeing of registered buyers, agents and workers is our highest priority. To ensure their safety. We are advising that entry to the stud sales complex should be limited to essential attendees, which will be determined by the duty agent hosting the sale.

Anyone experiencing cold or flu symptoms are requested to stay away from the facility altogether.

Every attendee will be required to register their attendance with the duty agent before being permitted entry (including all workers). If an attendee's presence is deemed non-essential, entry may not be granted.

Once onsite, attendees must practise social distancing by creating a 1.5m distance from others, exercise good hygiene. i.e. wash hands with soap and water for at least 20 seconds and use hand sanitiser (which has been placed in key locations).

Visitors from the same household will be permitted to sit beside each other. In all other circumstances the 1.5 distancing requirements will apply.

Additional measures include the availability of disposable gloves and masks and increased cleaning during peak periods.

We recognise that the management of this pandemic is continually evolving, with measure that can sometimes change on a near-daily basis. We will continue to monitor and implement any recommendations and control measure advised by the Australian and Queensland Governments.



## AuctionsPlus

### How to Register and Bid on AuctionsPlus

- 1 Go to [www.auctionsplus.com.au](http://www.auctionsplus.com.au) to register at least 48 hours before the sale.
- 2 Select "Sign Up" in the top right hand corner.
- 3 Fill out your name, mobile number, email address and create a password.
- 4 Go to your emails and confirm the account.
- 5 Return to AuctionsPlus and log in.
- 6 Select "Dashboard" and then select "Request Approval to Buy".
- 7 Fill in buyer details and once completed go back to Dashboard.
- 8 Complete buyer induction module (approx. 30 minutes).
- 9 AuctionsPlus will email you to let you know that your account has been approved.
- 10 Log in on sale day and connect to auction.
- 11 Bid using the two-step process – unlock the bid button and bid at that price.
- 12 If you are successful, the selling agent will contact you post sale to organise delivery and payment.

For more information please contact us on:

Phone: (02) 9262 4222

Email: [info@auctionsplus.com.au](mailto:info@auctionsplus.com.au)

## Sire Information



### Strathmore Magnetic M790 (PS)

**Sire:** Strathmore Big-Time B70 (AI)(ET)(P)

**Dam:** Strathmore H225 (P)

**Lots:** 11, 28, 43, 57 and 95

Strathmore Magnetic M790 (PS) son of Strathmore Big-Time B70 possesses volume. He is a clean coated bull with a very tidy sheath. Despite his size he is very mobile. He is a hard bull to contain during the off season.



### Strathmore Nantucket N440 (PP)

**Sire:** Strathmore Everest E594 (P)

**Dam:** Strathmore F163 (AI) (P)

**Lots:** 2, 6, 18, 32, 39, 45, 62, 72, 85, 90, 121, 125

Nantucket is a very sound bull that demonstrates great mobility. His work ethic is second to none siring 52 calves in his first season. The first of his calves are on offer in our sale this year. He maintains his condition well despite the country he covers and has remained sound. Nantucket's Dam Strathmore F163 (AI)(P) had all four of her progeny classified 'S'.

## Sire Information



### Strathmore Memphis M18 (AI) (PP)

**Sire:** Yarrowonga Avenger G300 (PS)

**Dam:** Strathmore J207 (P)

**Lots:** 21, 29, 31, 99 and 115

Strathmore Memphis M18 (AI) (PP) is hard to fault. He is a very stylish bull with great shape and a tonne of breed character. Memphis shows great thickness and muscle. He has great sire appeal, a strong polled head and on top of that is a Homozygous Poll. His Dam, J207 (P) went on to have five more calves in five years, Strathmore Periwinkle P352 (P) was sold in our 2019 Bull Sale, R602(PP) is Lot 41 in our 2020 Bull Sale. Memphis showed wonderful promise as a calf and he continues to impress us with his progeny.

### Strathmore Newton N10 (P)

**Sire:** Strathmore Everest E594 (P)

**Dam:** Strathmore E391

**Lots:** 7, 19, 27, 76, 97 and 109

Newton was retained in the stud in 2018. He was the best doing bull in his class. Newton has thickness and depth for days with a great spring of rib. He has a great carcass, a beautiful cherry red coat and he displays plenty of softness and a good strong polled head.

## Sire Information



### Yarrabee Elgin 1232 (P)

**Sire:** Hardigreen Park Lancer C12

**Dam:** Yarrabee Bobbie-Lee 6050

**Lots:** 8, 9, 52, 108 and 113

Elgin was purchased at the 2016 Rockhampton Sale, he had a daily weight gain of 1.05kg/day. At the time of purchasing Elgin, his dam had had 2 calves in 2 years and a DCI of 372. He is still a very active bull in the stud. Elgin has a beautiful tropical coat and a very tidy underline. He has length and a tonne of muscle. His temperament is very desirable and it shows in his progeny.



### Dangarfield Va-Voom V227 (PP)

**Sire:** Dangarfield Summit S20 (P)

**Dam:** Dangarfield F8307

**Lots:** 1, 5, 10, 23, 64 and 112

Purchased in 2013. He comes from a very fertile dam who had produced 14 calves at the time of his purchase. We saw a lot of potential in this bull as he is structurally sound and has a calm temperament. Va-Voom produces a very consistent product, all of his calves are muscly and compact. His calves are peas in a pod, and are easily identifiable at a glance.

## Sire Information



### Strathmore Juggler J406 (P)

**Sire:** Cobbora D110 (PS)

**Dam:** Strathmore B609

**Lots:** 3, 51, 93, 104 and 123

Juggler is an extremely impressive and stylish bull with a tonne of breed character. He sports a deep cherry red coat. He displays tremendous power and mobility which are traits that he passes onto his progeny. Juggler calves possess deep flanks, lovely loose skin with tidy sheaths, like their father they will grow into big bulls with plenty of breed character.



### ROSEVALE ULYSSES G474 (P)

**Sire:** Drensmaine Ulysses 821 (P)

**Dam:** Rosevale Zigzag Y539 (P)

**Lots:** 14, 41, 55, 66 and 103

Ulysses was purchased at the 2012 Rosevale Sale. He came from a fertile dam and had a weight gain of 1.17kg/day. Is a great big clean polled bull with a lot of sire appeal. He has grown into a massive bull and has a really tidy sheath. We continue to be impressed with his conception rate and post joining condition.

---

# STRAT)-(MORE

SANTA GERTRUDIS

*Bulls you can Bank on*



**WITH YOU EVERY  
STEP OF THE WAY**

Michael Smith  
P. 0428 64711  
Blake Munro  
P. 0428 862469

Brian Wedemeyer  
P. 0409 694696  
Anthony Ball  
P. 0428 275499

Andrew Meara  
P. 0427 210634  
Lisa Hedges  
P. 0427 891367

Adam Geddes  
P. 0427 500413  
Eliza Connors  
P. 0419 644813

**Elders**

---

21st Annual  
**On-Property Bull Sale**

**Lot 1 - 130**

Purebred Santa Gertrudis Bulls



# 1 Strathmore Roller R86 (PP)

<b>SB Number</b>	STR20MR86	<b>Birth Date</b>	31/10/2019
<b>Fire Brand</b>	R86	<b>Classification</b>	S Bull



## Pedigree

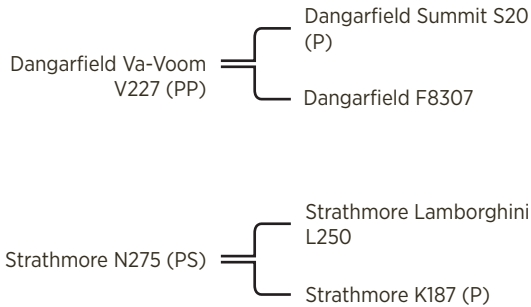

## Dam Notes

Dam DOB 24/12/2016 # Calves 1

## Calving Dates

31/10/2019

Purchaser ..... \$ .....

# 2 Strathmore Rodeo R458 (PP)

<b>SB Number</b>	STR20MR458	<b>Birth Date</b>	28/11/2019
<b>Fire Brand</b>	R458	<b>Classification</b>	S Bull



## Pedigree

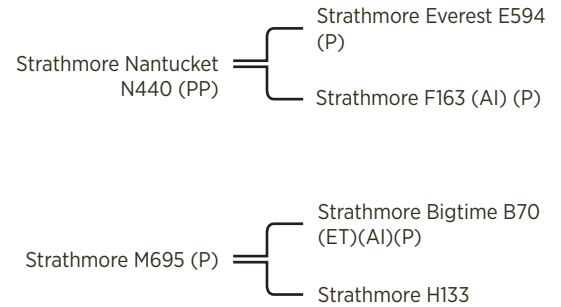

## Dam Notes

Dam DOB 9/11/2015 # Calves 3

## Calving Dates

1/12/2018, 28/11/2019, 17/11/2020

Purchaser ..... \$ .....

### 3 Strathmore Rocco R212 (P)

<b>SB Number</b>	STR20MR212	<b>Birth Date</b>	5/11/2019
<b>Fire Brand</b>	R212	<b>Classification</b>	S Bull



#### Pedigree

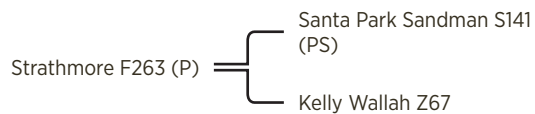
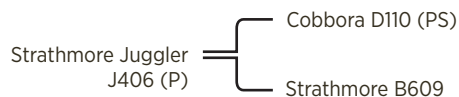

#### Dam Notes

Dam DOB 6/12/2009 # Calves 9

#### Calving Dates

11/11/2012, 16/12/2013, 17/01/2015, 2/12/2015, 3/12/2016, 23/10/2017, 15/01/2019, 5/11/2019, 20/10/2020

Purchaser ..... \$ .....

### 4 Strathmore Reclaimer R330C (PP)

<b>SB Number</b>	STR20MR330C	<b>Birth Date</b>	23/01/2020
<b>Fire Brand</b>	R330	<b>Classification</b>	S Bull



#### Pedigree

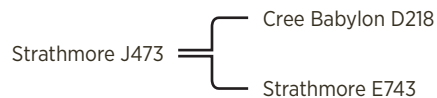
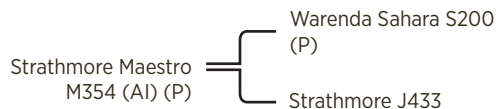

#### Dam Notes

Dam DOB 2/06/2013 # Calves 6

#### Calving Dates

29/11/2015, 4/02/2017, 22/02/2018, 2/02/2019, 23/01/2020, 1/01/2021

Purchaser ..... \$ .....

# 5 Strathmore Roamer R342 (P)

<b>SB Number</b>	STR20MR342	<b>Birth Date</b>	10/10/2019
<b>Fire Brand</b>	R342	<b>Classification</b>	S Bull



## Pedigree

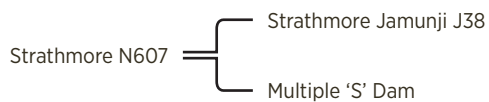
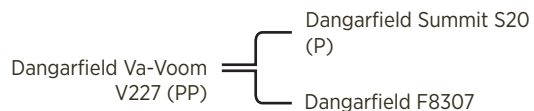

## Dam Notes

Dam DOB 18/11/2016 # Calves 2

## Calving Dates

10/10/2019, 20/11/2020

Purchaser ..... \$ .....

# 6 Strathmore Regal R498 (P)

<b>SB Number</b>	STR20MR498	<b>Birth Date</b>	10/11/2019
<b>Fire Brand</b>	R498	<b>Classification</b>	S Bull



## Pedigree

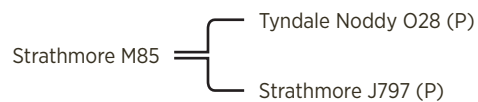
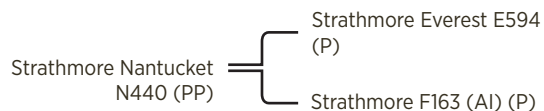

## Dam Notes

Dam DOB 1/12/2015 # Calves 3

## Calving Dates

21/05/2018, 10/11/2019, 9/11/2020

Purchaser ..... \$ .....

# 7 Strathmore Raconteur R146 (PP)

<b>SB Number</b>	STR20MR146	<b>Birth Date</b>	4/11/2019
<b>Fire Brand</b>	R146	<b>Classification</b>	S Bull



## Pedigree

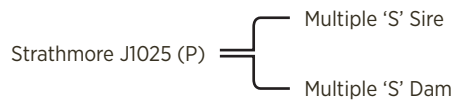
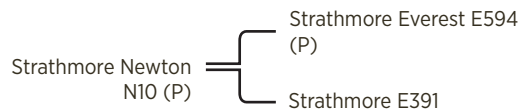

## Dam Notes

Dam DOB 1/01/2013 # Calves 6

## Calving Dates

2/12/2015, 29/01/2017, 20/12/2017, 15/11/2018, 4/11/2019, 20/10/2020

Purchaser ..... \$ .....

# 8 Strathmore Reggie R6 (PS)

<b>SB Number</b>	STR20MR6	<b>Birth Date</b>	27/10/2019
<b>Fire Brand</b>	R6	<b>Classification</b>	S Bull



## Pedigree

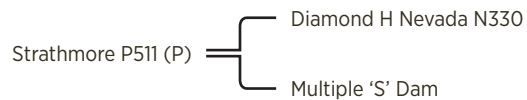
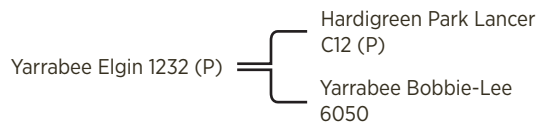

## Dam Notes

Dam DOB 4/11/2017 # Calves 2

## Calving Dates

27/10/2019, 3/10/2020

Purchaser ..... \$ .....

# 9 Strathmore Rodrigues R8 (P)

<b>SB Number</b>	STR20MR8	<b>Birth Date</b>	5/11/2019
<b>Fire Brand</b>	R8	<b>Classification</b>	S Bull



## Pedigree

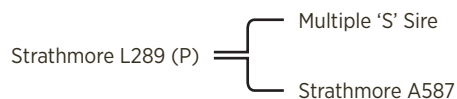
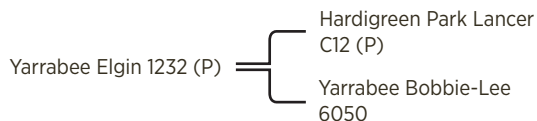

## Dam Notes

Dam DOB 22/01/2015 # Calves 4

## Calving Dates

1/12/2017, 11/12/2018, 5/11/2019, 1/11/2020

Purchaser ..... \$ .....

# 10 Strathmore Retro R344 (PS)

<b>SB Number</b>	STR20MR344	<b>Birth Date</b>	6/11/2019
<b>Fire Brand</b>	R344	<b>Classification</b>	S Bull



## Pedigree

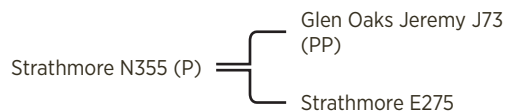
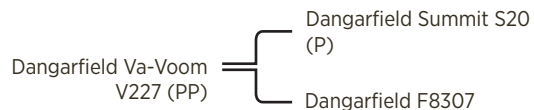

## Dam Notes

Dam DOB 15/11/2016 # Calves 2

## Calving Dates

6/11/2019, 2/11/2020

Purchaser ..... \$ .....

# 11 Strathmore Recruit R370 (PS)

<b>SB Number</b>	STR20MR370	<b>Birth Date</b>	15/10/2019
<b>Fire Brand</b>	R370	<b>Classification</b>	S Bull



## Pedigree

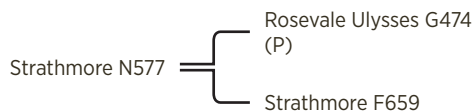
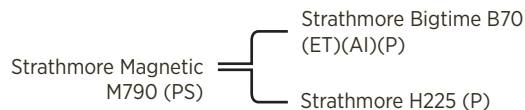

## Dam Notes

Dam DOB 3/12/2016 # Calves 2

## Calving Dates

15/10/2019, 5/11/2020

Purchaser ..... \$ .....

# 12 Strathmore Remedy R590 (P)

<b>SB Number</b>	STR20MR590	<b>Birth Date</b>	30/12/2019
<b>Fire Brand</b>	R590	<b>Classification</b>	S Bull



## Pedigree

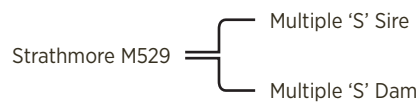
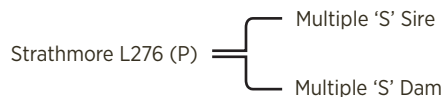

## Dam Notes

Dam DOB 22/12/2015 # Calves 3

## Calving Dates

3/11/2018, 30/12/2019, 30/11/2020

Purchaser ..... \$ .....

# 13 Strathmore Russell R200 (P)

<b>SB Number</b>	STR20MR200	<b>Birth Date</b>	10/10/2019
<b>Fire Brand</b>	R200	<b>Classification</b>	S Bull



## Pedigree

Rowanlea Lawson L66 (P) — Rowanlea Grandslam G36  
 — Rowanlea Donata D87 (P)

Strathmore L275 (P) — Rosevale Buster F236 (P)  
 — Strathmore A601

## Dam Notes

Dam DOB 15/12/2014 # Calves 3

## Calving Dates

7/10/2017, 16/11/2018, 10/10/2019

Purchaser ..... \$ .....

# 14 Strathmore Roderick R586 (P)

<b>SB Number</b>	STR20MR586	<b>Birth Date</b>	13/12/2019
<b>Fire Brand</b>	R586	<b>Classification</b>	S Bull

## Pedigree

Rosevale Ulysses G474 (P) — Drensmaine Ulysses 821 (P)  
 — Rosevale Zigzag Y539 (P)

Strathmore M439 — Multiple 'S' Sire  
 — Multiple 'S' Dam

## Dam Notes

Dam DOB 14/12/2015 # Calves 3

## Calving Dates

15/12/2018, 13/12/2019, 10/11/2020

Purchaser ..... \$ .....



# 15 Strathmore Randy R568 (P)

<b>SB Number</b>	STR20MR568	<b>Birth Date</b>	25/11/2019
<b>Fire Brand</b>	R568	<b>Classification</b>	S Bull



## Pedigree

Strathmore L276 (P) = { Multiple 'S' Sire  
Multiple 'S' Dam

Strathmore J51 (P) = { Gylanda D764 (P)  
Strathmore A11 (P)

## Dam Notes

Dam DOB 18/11/2012 # Calves 6

## Calving Dates

30/11/2015, 6/12/2016, 18/11/2017, 20/11/2018,  
25/11/2019, 4/11/2020

Purchaser ..... \$ .....

# 16 Strathmore Rocket R176 (P)

<b>SB Number</b>	STR20MR176	<b>Birth Date</b>	24/10/2019
<b>Fire Brand</b>	R176	<b>Classification</b>	S Bull

## Pedigree

Strathmore Nasa N280 (PP) = { Glen Oaks Jeremy J73 (PP)  
Strathmore J809

Strathmore K869 (P) = { Multiple 'S' Sire  
Multiple 'S' Dam

## Dam Notes

Dam DOB 13/12/2013 # Calves 4

## Calving Dates

20/11/2016, 3/12/2017, 12/11/2018, 24/10/2019

Purchaser ..... \$ .....





# 17 Strathmore Ripper R280 (PS)

<b>SB Number</b>	STR20MR280	<b>Birth Date</b>	14/01/2020
<b>Fire Brand</b>	R280	<b>Classification</b>	S Bull



### Pedigree

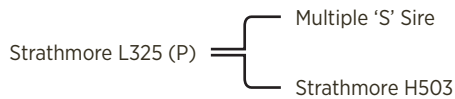
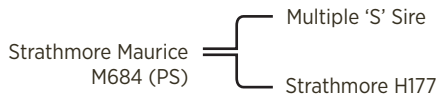

### Dam Notes

Dam DOB 1/02/2015 # Calves 4

### Calving Dates

15/10/2017, 31/10/2018, 14/01/2020, 25/01/2021

Purchaser ..... \$ .....

# 18 Strathmore Romeo R122 (P)

<b>SB Number</b>	STR20MR122	<b>Birth Date</b>	29/10/2019
<b>Fire Brand</b>	R122	<b>Classification</b>	S Bull



### Pedigree

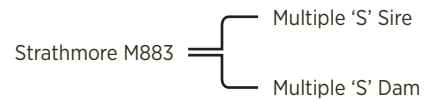
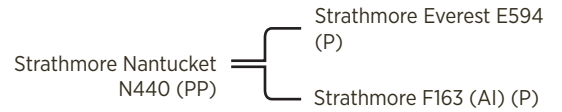

### Dam Notes

Dam DOB 30/01/2016 # Calves 2

### Calving Dates

4/07/2018, 29/10/2019

Purchaser ..... \$ .....

# 19 Strathmore Rudolph R132 (P)

<b>SB Number</b>	STR20MR132	<b>Birth Date</b>	5/12/2019
<b>Fire Brand</b>	R132	<b>Classification</b>	S Bull



## Pedigree

Strathmore Newton N10 (P) ———— { Strathmore Everest E594 (P)  
Strathmore E391

Strathmore K081 ———— { Multiple 'S' Sire  
Multiple 'S' Dam

## Dam Notes

Dam DOB 18/11/2013 # Calves 5

## Calving Dates

8/01/2017, 2/12/2017, 19/11/2018, 5/12/2019, 10/11/2020

Purchaser ..... \$ .....

# 20 Strathmore River-Boy R346 (PS)

<b>SB Number</b>	STR20MR346	<b>Birth Date</b>	10/10/2019
<b>Fire Brand</b>	R346	<b>Classification</b>	S Bull

## Pedigree

Strathmore J274 (PS) ———— { Strathmore Bigtime B70 (ET)(AI)(P)  
Strathmore A453

Strathmore N565 (P) ———— { Strathmore Kindred K600 (P)  
Strathmore F479

## Dam Notes

Dam DOB 11/01/2017 # Calves 2

## Calving Dates

10/10/2019, 2/11/2020

Purchaser ..... \$ .....



# 21 Strathmore R444 (PP)

<b>SB Number</b>	STR20MR444	<b>Birth Date</b>	15/12/2019
<b>Fire Brand</b>	R444	<b>Classification</b>	S Bull



## Pedigree

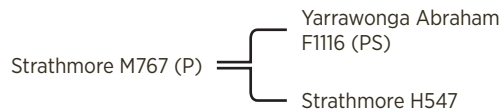
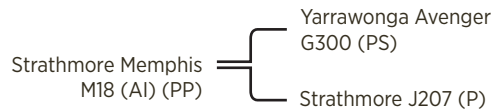

## Dam Notes

Dam DOB 1/02/2016 # Calves 3

## Calving Dates

5/11/2018, 15/12/2019, 17/11/2020

Purchaser ..... \$ .....

# 22 Strathmore R202 (PP)

<b>SB Number</b>	STR20MR202	<b>Birth Date</b>	15/12/2019
<b>Fire Brand</b>	R202	<b>Classification</b>	S Bull



## Pedigree

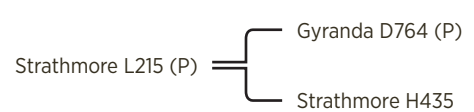
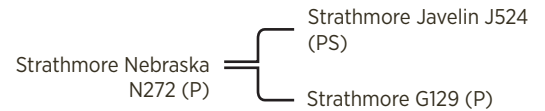

## Dam Notes

Dam DOB 15/12/2014 # Calves 4

## Calving Dates

15/09/2017, 30/10/2018, 15/12/2019, 9/11/2020

Purchaser ..... \$ .....

# 23 Strathmore R84 (PP)

<b>SB Number</b>	STR20MR84	<b>Birth Date</b>	15/12/2019
<b>Fire Brand</b>	R84	<b>Classification</b>	S Bull



## Pedigree

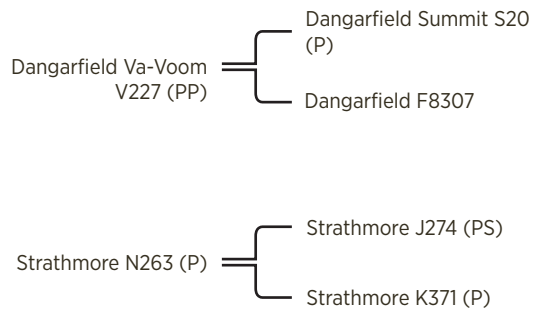

## Dam Notes

Dam DOB 16/01/2017 # Calves 2

## Calving Dates

15/12/2019, 2/03/2021

Purchaser ..... \$ .....

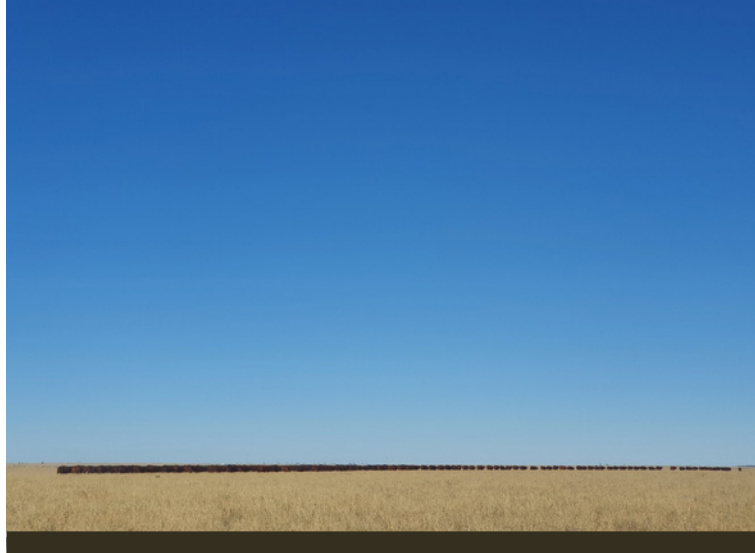

# 24 Strathmore R194 (PS)

<b>SB Number</b>	STR20MR194	<b>Birth Date</b>	1/01/2020
<b>Fire Brand</b>	R194	<b>Classification</b>	S Bull



Pedigree

Strathmore H448 (P) = { Multiple 'S' Sire  
Strathmore Y151

Multiple 'S' Dam = {

Dam Notes

Dam DOB # Calves

Calving Dates

Purchaser ..... \$ .....

# 25 Strathmore R496 (PP)

<b>SB Number</b>	STR20MR496	<b>Birth Date</b>	12/12/2019
<b>Fire Brand</b>	R496	<b>Classification</b>	S Bull



Pedigree

Forest Park Kojak M594 (PP) = { Forest Park Glow 9336 (P)  
Forest Park 5876 (P)

Strathmore M477 = { Multiple 'S' Sire  
Multiple 'S' Dam

Dam Notes

Dam DOB 7/12/2015 # Calves 3

Calving Dates

7/12/2018, 12/12/2019, 9/12/2020

Purchaser ..... \$ .....

# 26 Strathmore R500 (P)

<b>SB Number</b>	STR20MR500	<b>Birth Date</b>	5/11/2019
<b>Fire Brand</b>	R500	<b>Classification</b>	S Bull



## Pedigree

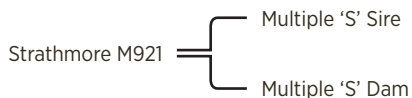
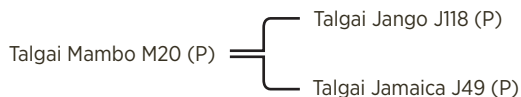

## Dam Notes

Dam DOB 30/01/2016 # Calves 2

## Calving Dates

7/12/2018, 5/11/2019

Purchaser ..... \$ .....

# 27 Strathmore R126 (P)

<b>SB Number</b>	STR20MR126	<b>Birth Date</b>	5/11/2019
<b>Fire Brand</b>	R126	<b>Classification</b>	S Bull

## Pedigree

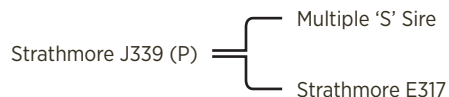
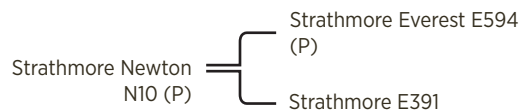

## Dam Notes

Dam DOB 20/02/2013 # Calves 6

## Calving Dates

5/01/2016, 14/01/2017, 26/11/2017, 13/11/2018, 5/11/2019, 5/10/2020

Purchaser ..... \$ .....



# 28 Strathmore R98 (P)

<b>SB Number</b>	STR20MR98	<b>Birth Date</b>	16/11/2019
<b>Fire Brand</b>	R98	<b>Classification</b>	S Bull



## Pedigree

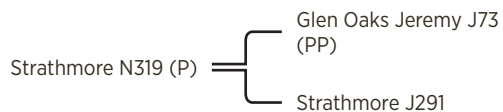
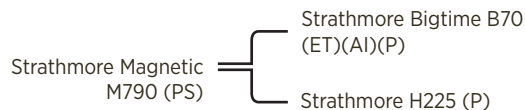

## Dam Notes

Dam DOB 19/11/2016 # Calves 1

## Calving Dates

16/11/2019

Purchaser ..... \$ .....

# 29 Strathmore R454 (PS)

<b>SB Number</b>	STR20MR454	<b>Birth Date</b>	19/11/2019
<b>Fire Brand</b>	R454	<b>Classification</b>	S Bull

## Pedigree

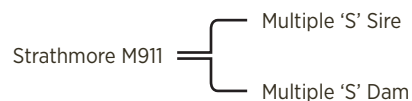
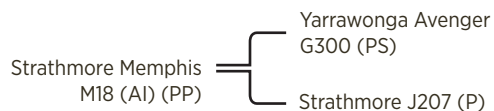

## Dam Notes

Dam DOB 30/01/2016 # Calves 3

## Calving Dates

12/11/2018, 19/11/2019, 26/10/2020

Purchaser ..... \$ .....



# 30 Strathmore R532 (PS)

<b>SB Number</b>	STR20MR532	<b>Birth Date</b>	18/12/2019
<b>Fire Brand</b>	R532	<b>Classification</b>	S Bull



## Pedigree

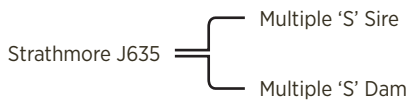
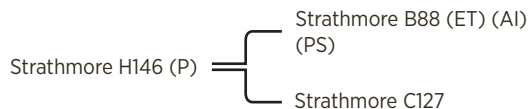

## Dam Notes

Dam DOB 19/03/2013 # Calves 5

## Calving Dates

12/12/2016, 1/01/2018, 21/12/2018, 18/12/2019, 28/11/2020

Purchaser ..... \$ .....

# 31 Strathmore R436 (P)

<b>SB Number</b>	STR20MR436	<b>Birth Date</b>	31/12/2019
<b>Fire Brand</b>	R436	<b>Classification</b>	S Bull

## Pedigree

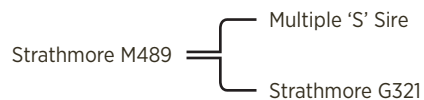
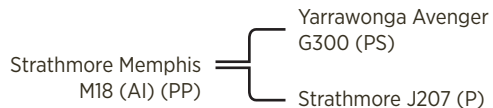

## Dam Notes

Dam DOB 5/12/2015 # Calves 3

## Calving Dates

4/10/2018, 31/12/2019, 5/01/2021

Purchaser ..... \$ .....

# 32 Strathmore R470 (P)

<b>SB Number</b>	STR20MR470	<b>Birth Date</b>	20/12/2019
<b>Fire Brand</b>	R470	<b>Classification</b>	S Bull

## Pedigree

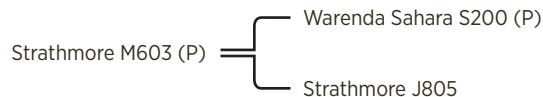
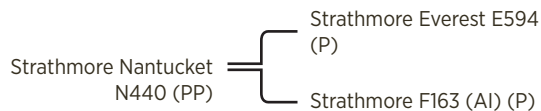

## Dam Notes

Dam DOB 8/11/2015 # Calves 3

## Calving Dates

25/04/2018, 20/12/2019, 10/12/2020

Purchaser ..... \$ .....



# 33 Strathmore R220 (PP)

<b>SB Number</b>	STR20MR220	<b>Birth Date</b>	12/11/2019
<b>Fire Brand</b>	R220	<b>Classification</b>	S Bull

## Pedigree

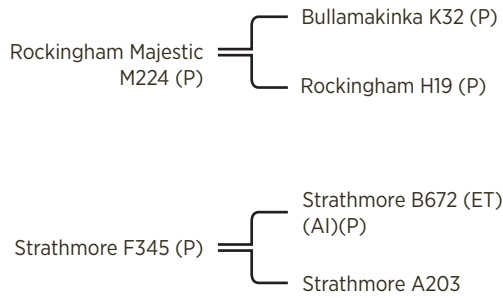

## Dam Notes

Dam DOB 24/11/2009 # Calves 8

## Calving Dates

10/11/2012, 5/12/2013, 20/12/2014, 18/12/2015, 4/12/2016, 16/11/2017, 12/11/2019, 30/11/2020

Purchaser ..... \$ .....



# 34 Strathmore R40 (PP)

<b>SB Number</b>	STR20MR40	<b>Birth Date</b>	20/12/2019
<b>Fire Brand</b>	R40	<b>Classification</b>	S Bull



## Pedigree

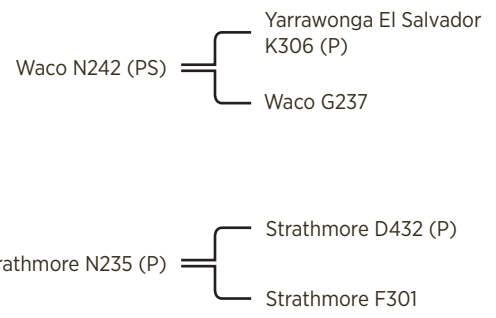

## Dam Notes

Dam DOB 3/02/2017 # Calves 2

## Calving Dates

20/12/2019, 13/12/2020

Purchaser ..... \$ .....

# 35 Strathmore R528 (P)

<b>SB Number</b>	STR20MR528	<b>Birth Date</b>	15/12/2019
<b>Fire Brand</b>	R528	<b>Classification</b>	S Bull



## Pedigree

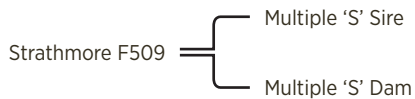
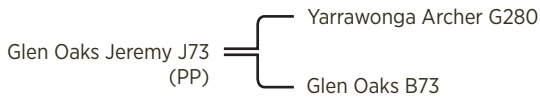

## Dam Notes

Dam DOB 11/12/2009 # Calves 8

## Calving Dates

18/12/2012, 7/12/2013, 16/12/2014, 9/12/2015, 3/12/2016,  
 13/12/2017, 30/11/2018, 15/12/2019

Purchaser ..... \$ .....

# 36 Strathmore R324C (P)

<b>SB Number</b>	STR20MR324C	<b>Birth Date</b>	14/12/2019
<b>Fire Brand</b>	R324	<b>Classification</b>	S Bull

## Pedigree

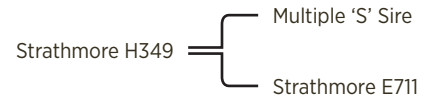
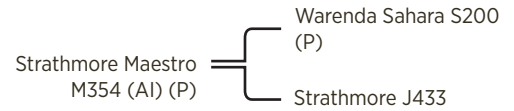

## Dam Notes

Dam DOB 1/11/2011 # Calves 6

## Calving Dates

24/01/2016, 6/02/2017, 23/01/2018, 5/01/2019,  
 14/12/2019, 21/12/2020

Purchaser ..... \$ .....



# 37 Strathmore R326 (PS)

<b>SB Number</b>	STR20MR326	<b>Birth Date</b>	21/11/2019
<b>Fire Brand</b>	R326	<b>Classification</b>	S Bull



## Pedigree

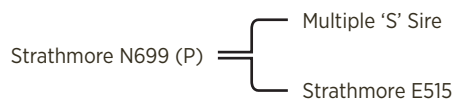
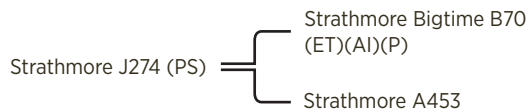

## Dam Notes

Dam DOB 10/01/2017 # Calves 3

## Calving Dates

25/12/2018, 21/11/2019, 15/12/2020

Purchaser ..... \$ .....

# 38 Strathmore R508 (PP)

<b>SB Number</b>	STR20MR508	<b>Birth Date</b>	20/11/2019
<b>Fire Brand</b>	R508	<b>Classification</b>	S Bull

## Pedigree

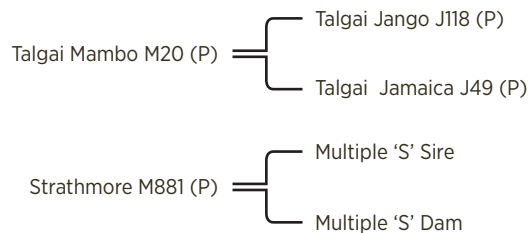

## Dam Notes

Dam DOB 30/01/2016 # Calves 2

## Calving Dates

25/11/2018, 20/11/2019

Purchaser ..... \$ .....

# 39 Strathmore R506 (PP)

<b>SB Number</b>	STR20MR506	<b>Birth Date</b>	7/12/2019
<b>Fire Brand</b>	R506	<b>Classification</b>	S Bull

## Pedigree

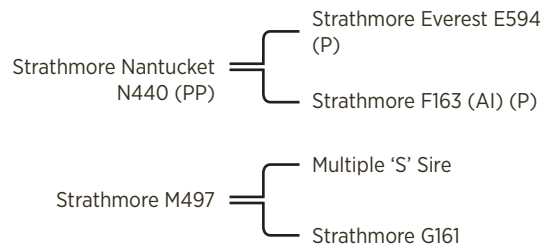

## Dam Notes

Dam DOB 18/11/2015 # Calves 3

## Calving Dates

8/09/2018, 7/12/2019, 5/12/2020

Purchaser ..... \$ .....

# 40 Strathmore R602 (PP)

<b>SB Number</b>	STR20MR602	<b>Birth Date</b>	5/12/2019
<b>Fire Brand</b>	R602	<b>Classification</b>	S Bull

## Pedigree

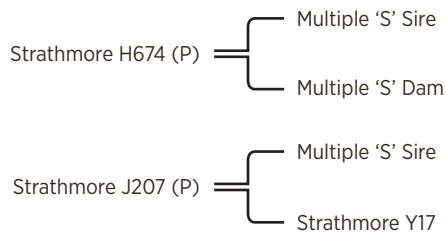

## Dam Notes

Dam DOB 1/01/2013 # Calves 6

## Calving Dates

4/12/2015, 26/12/2016, 28/11/2017, 23/12/2018,  
5/12/2019, 24/02/2021

Purchaser ..... \$ .....

# 41 Strathmore R572 (PS)

<b>SB Number</b>	STR20MR572	<b>Birth Date</b>	10/11/2019
<b>Fire Brand</b>	R572	<b>Classification</b>	S Bull

## Pedigree

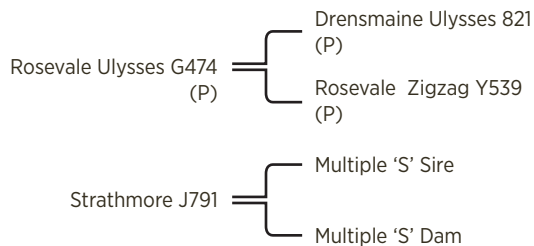

## Dam Notes

Dam DOB 1/09/2012 # Calves 5

## Calving Dates

25/11/2016, 11/11/2017, 3/11/2018, 10/11/2019, 5/11/2020

Purchaser ..... \$ .....

# 42 Strathmore R318C (P)

<b>SB Number</b>	STR20MR318C	<b>Birth Date</b>	4/01/2020
<b>Fire Brand</b>	R318	<b>Classification</b>	S Bull

## Pedigree

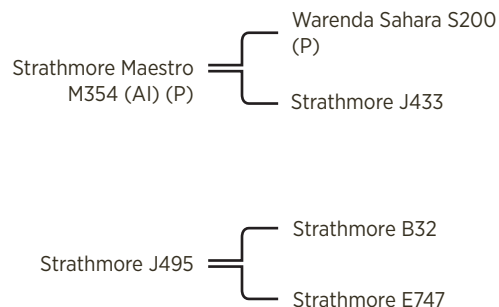

## Dam Notes

Dam DOB 17/01/2013 # Calves 5

## Calving Dates

10/11/2015, 12/11/2016, 5/11/2017, 20/12/2018, 4/01/2020

Purchaser ..... \$ .....



# 43 Strathmore R2 (PS)

<b>SB Number</b>	STR20MR2	<b>Birth Date</b>	10/10/2019
<b>Fire Brand</b>	R2	<b>Classification</b>	S Bull



## Pedigree

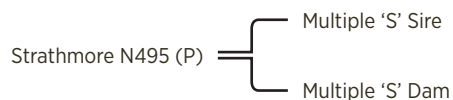
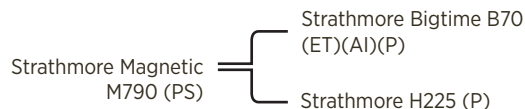

## Dam Notes

Dam DOB 22/12/2016 # Calves 2

## Calving Dates

10/10/2019, 29/10/2020

Purchaser ..... \$ .....

# 44 Strathmore R94 (P)

<b>SB Number</b>	STR20MR94	<b>Birth Date</b>	30/10/2019
<b>Fire Brand</b>	R94	<b>Classification</b>	S Bull

## Pedigree

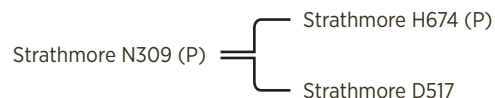
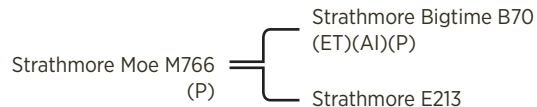

## Dam Notes

Dam DOB 26/02/2017 # Calves 1

## Calving Dates

30/10/2019

Purchaser ..... \$ .....

# 45 Strathmore R452 (PS)

<b>SB Number</b>	STR20MR452	<b>Birth Date</b>	19/12/2019
<b>Fire Brand</b>	R452	<b>Classification</b>	S Bull

## Pedigree

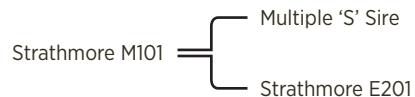
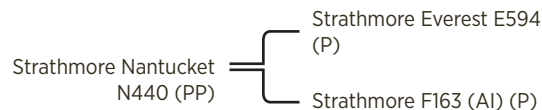

## Dam Notes

Dam DOB 9/01/2016 # Calves 2

## Calving Dates

15/01/2019, 19/12/2019

Purchaser ..... \$ .....

# 46 Strathmore R368 (P)

<b>SB Number</b>	STR20MR368	<b>Birth Date</b>	10/01/2020
<b>Fire Brand</b>	R368	<b>Classification</b>	S Bull

## Pedigree

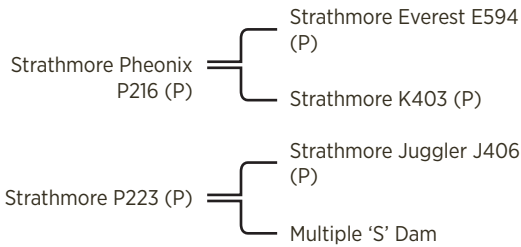

## Dam Notes

Dam DOB 17/11/2017 # Calves 2

## Calving Dates

10/01/2020, 19/12/2020

Purchaser ..... \$ .....

# 47 Strathmore R234

<b>SB Number</b>	STR20MR234	<b>Birth Date</b>	3/12/2019
<b>Fire Brand</b>	R234	<b>Classification</b>	S Bull

## Pedigree

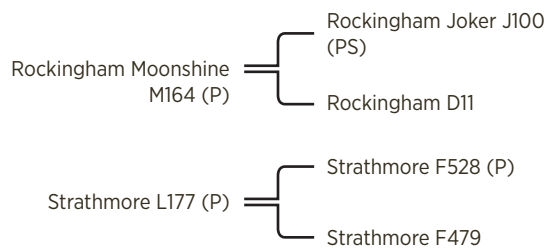

## Dam Notes

Dam DOB 28/12/2014 # Calves 4

## Calving Dates

13/09/2017, 18/12/2018, 3/12/2019, 2/11/2020

Purchaser ..... \$ .....

# 48 Strathmore R268

<b>SB Number</b>	STR20MR268	<b>Birth Date</b>	11/02/2020
<b>Fire Brand</b>	R268	<b>Classification</b>	S Bull

## Pedigree

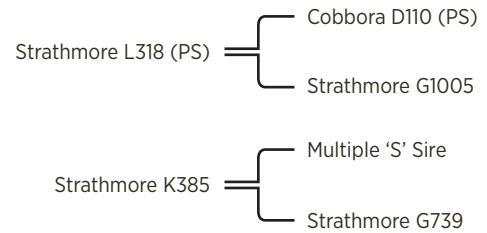

## Dam Notes

Dam DOB 15/11/2013 # Calves 4

## Calving Dates

1/02/2017, 12/02/2018, 2/01/2019, 11/02/2020

Purchaser ..... \$ .....

# 49 Strathmore R208

<b>SB Number</b>	STR20MR208	<b>Birth Date</b>	20/12/2019
<b>Fire Brand</b>	R208	<b>Classification</b>	S Bull

## Pedigree

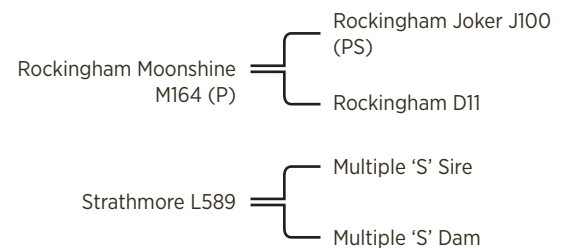

## Dam Notes

Dam DOB 1/12/2014 # Calves 4

## Calving Dates

24/09/2017, 29/01/2019, 20/12/2019, 23/12/2020

Purchaser ..... \$ .....

# 50 Strathmore R328

<b>SB Number</b>	STR20MR328	<b>Birth Date</b>	6/11/2019
<b>Fire Brand</b>	R328	<b>Classification</b>	S Bull

## Pedigree

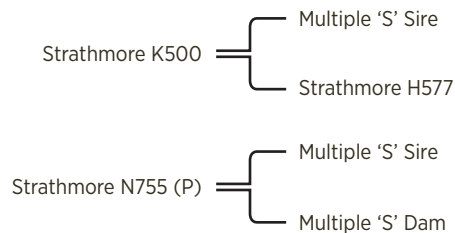

## Dam Notes

Dam DOB 29/12/2016 # Calves 2

## Calving Dates

15/12/2018, 6/11/2019

Purchaser ..... \$ .....

# 51 Strathmore R242

<b>SB Number</b>	STR20MR242	<b>Birth Date</b>	10/10/2019
<b>Fire Brand</b>	R242	<b>Classification</b>	S Bull

## Pedigree

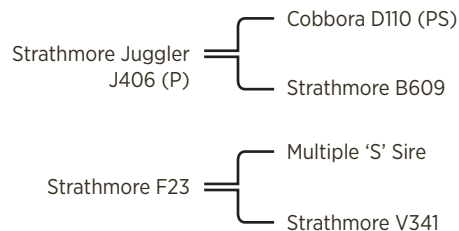

## Dam Notes

Dam DOB 1/05/2009 # Calves 9

## Calving Dates

1/12/2012, 26/11/2013, 3/01/2015, 16/12/2015, 30/11/2016, 18/10/2017, 28/10/2018, 10/10/2019, 26/09/2020

Purchaser ..... \$ .....

# 52 Strathmore R92

<b>SB Number</b>	STR20MR92	<b>Birth Date</b>	20/10/2019
<b>Fire Brand</b>	R92	<b>Classification</b>	S Bull

## Pedigree

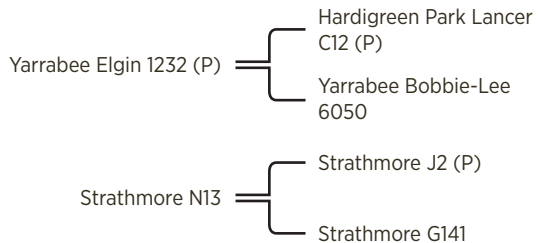

## Dam Notes

Dam DOB 21/12/2016 # Calves 2

## Calving Dates

20/10/2019, 15/12/2020

Purchaser ..... \$ .....

# 53 Strathmore R548

<b>SB Number</b>	STR20MR548	<b>Birth Date</b>	8/12/2019
<b>Fire Brand</b>	R548	<b>Classification</b>	S Bull

## Pedigree

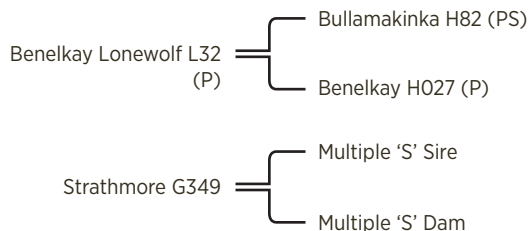

## Dam Notes

Dam DOB 1/09/2010 # Calves 8

## Calving Dates

11/12/2013, 9/12/2014, 15/12/2015, 6/12/2016, 18/12/2017, 3/12/2018, 8/12/2019, 10/12/2020

Purchaser ..... \$ .....

**STRAT)-(MORE**

SANTA GERTRUDIS

*Bulls you can Bank on*





# 54 Strathmore R18

<b>SB Number</b>	STR20MR18	<b>Birth Date</b>	12/11/2019
<b>Fire Brand</b>	R18	<b>Classification</b>	S Bull

## Pedigree

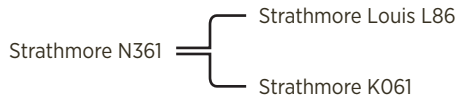
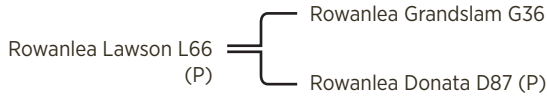

## Dam Notes

Dam DOB 26/11/2016 # Calves 2

## Calving Dates

12/11/2019, 2/10/2020

Purchaser ..... \$ .....

# 55 Strathmore R324

<b>SB Number</b>	STR20MR324	<b>Birth Date</b>	22/12/2019
<b>Fire Brand</b>	R324	<b>Classification</b>	S Bull

## Pedigree

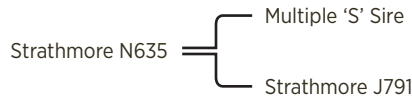
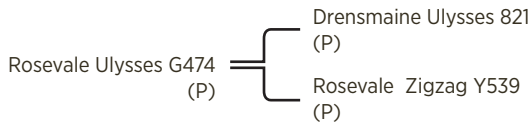

## Dam Notes

Dam DOB 25/11/2016 # Calves 3

## Calving Dates

15/01/2019, 22/12/2019, 10/10/2020

Purchaser ..... \$ .....

# 56 Strathmore R376

<b>SB Number</b>	STR20MR376	<b>Birth Date</b>	15/01/2020
<b>Fire Brand</b>	R376	<b>Classification</b>	S Bull

## Pedigree

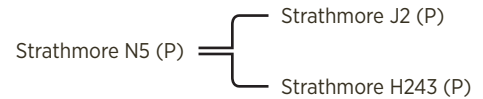
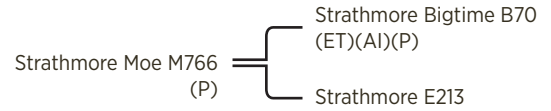

## Dam Notes

Dam DOB 1/12/2016 # Calves 2

## Calving Dates

15/01/2020, 5/12/2020

Purchaser ..... \$ .....

# 57 Strathmore R374

<b>SB Number</b>	STR20MR374	<b>Birth Date</b>	26/10/2019
<b>Fire Brand</b>	R374	<b>Classification</b>	S Bull

## Pedigree

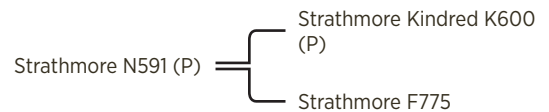
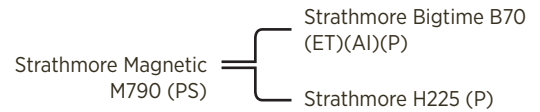

## Dam Notes

Dam DOB 31/12/2016 # Calves 2

## Calving Dates

26/10/2019, 1/12/2020

Purchaser ..... \$ .....

# 58 Strathmore R308

<b>SB Number</b>	STR20MR308	<b>Birth Date</b>	15/10/2019
<b>Fire Brand</b>	R308	<b>Classification</b>	S Bull

## Pedigree

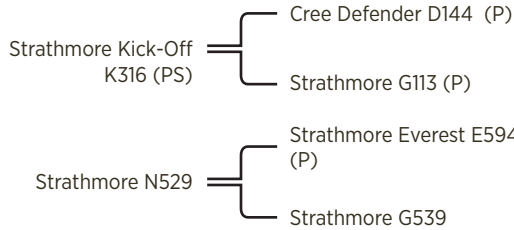

## Dam Notes

Dam DOB 28/12/2016 # Calves 2

## Calving Dates

10/12/2018, 15/10/2019

Purchaser ..... \$ .....

# 59 Strathmore R272

<b>SB Number</b>	STR20MR272	<b>Birth Date</b>	29/01/2020
<b>Fire Brand</b>	R272	<b>Classification</b>	S Bull

## Pedigree

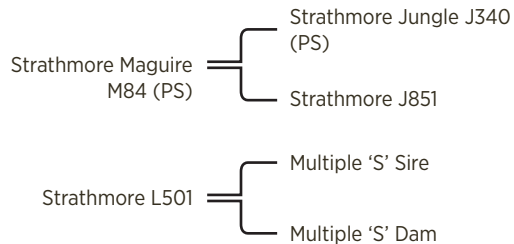

## Dam Notes

Dam DOB 1/01/2015 # Calves 4

## Calving Dates

21/11/2017, 6/01/2019, 29/01/2020, 12/01/2021

Purchaser ..... \$ .....

# 60 Strathmore R584

<b>SB Number</b>	STR20MR584	<b>Birth Date</b>	1/01/2020
<b>Fire Brand</b>	R584	<b>Classification</b>	S Bull

## Pedigree

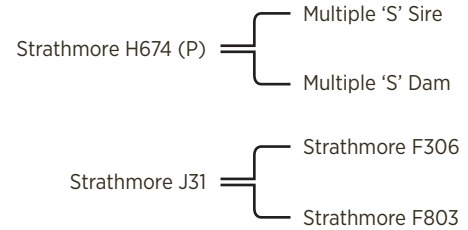

## Dam Notes

Dam DOB 5/12/2012 # Calves 5

## Calving Dates

14/11/2015, 7/03/2017, 21/02/2018, 9/02/2019, 1/01/2020

Purchaser ..... \$ .....

# 61 Strathmore R320C (P)

<b>SB Number</b>	STR20MR320C	<b>Birth Date</b>	15/12/2019
<b>Fire Brand</b>	R320	<b>Classification</b>	S Bull

## Pedigree

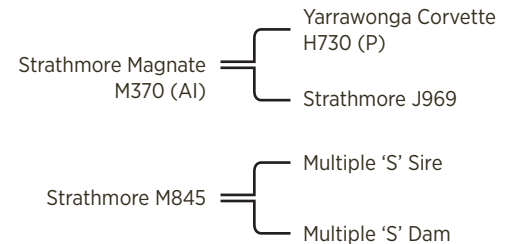

## Dam Notes

Dam DOB 30/01/2016 # Calves 3

## Calving Dates

2/01/2019, 15/12/2019, 2/12/2020

Purchaser ..... \$ .....

# 62 Strathmore R460 (PP)

<b>SB Number</b>	STR20MR460	<b>Birth Date</b>	14/10/2019
<b>Fire Brand</b>	R460	<b>Classification</b>	S Bull

## Pedigree

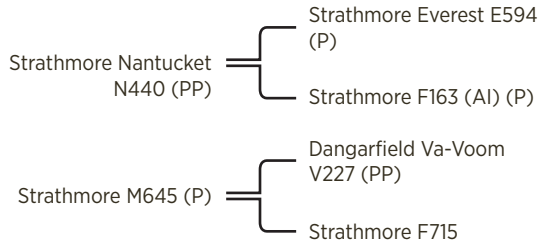

## Dam Notes

Dam DOB 30/12/2015 # Calves 3

## Calving Dates

10/06/2018, 14/10/2019, 21/10/2020

Purchaser ..... \$ .....

# 63 Strathmore R326C (P)

<b>SB Number</b>	STR20MR326C	<b>Birth Date</b>	17/01/2020
<b>Fire Brand</b>	R326	<b>Classification</b>	S Bull

## Pedigree

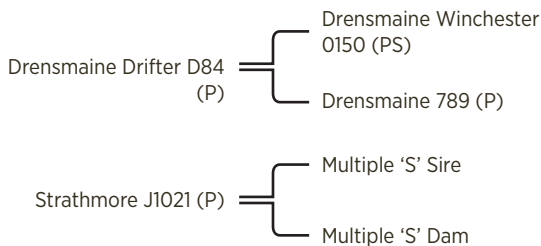

## Dam Notes

Dam DOB 1/01/2013 # Calves 5

## Calving Dates

2/12/2015, 13/02/2017, 1/02/2018, 14/01/2019, 17/01/2020

Purchaser ..... \$ .....

# 64 Strathmore R334 (P)

<b>SB Number</b>	STR20MR334	<b>Birth Date</b>	15/12/2019
<b>Fire Brand</b>	R334	<b>Classification</b>	S Bull

## Pedigree

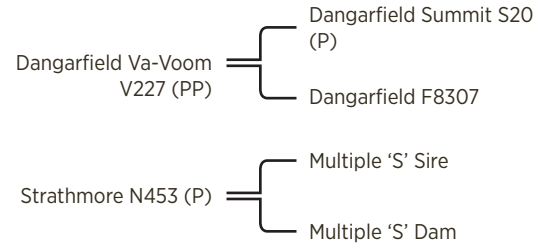

## Dam Notes

Dam DOB 6/12/2016 # Calves 3

## Calving Dates

8/01/2019, 15/12/2019, 17/11/2020

Purchaser ..... \$ .....

# 65 Strathmore R440 (PS)

<b>SB Number</b>	STR20MR440	<b>Birth Date</b>	7/12/2019
<b>Fire Brand</b>	R440	<b>Classification</b>	S Bull

## Pedigree

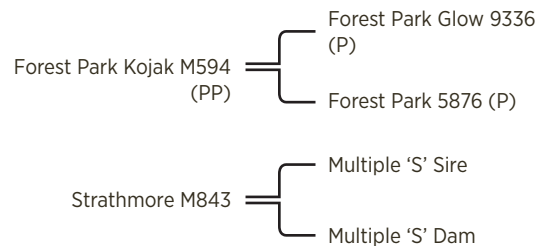

## Dam Notes

Dam DOB 30/01/2016 # Calves 3

## Calving Dates

26/12/2018, 7/12/2019, 19/02/2021

Purchaser ..... \$ .....

# 66 Strathmore R598 (PS)

<b>SB Number</b>	STR20MR598	<b>Birth Date</b>	28/11/2019
<b>Fire Brand</b>	R598	<b>Classification</b>	S Bull

## Pedigree

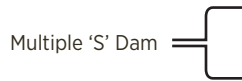
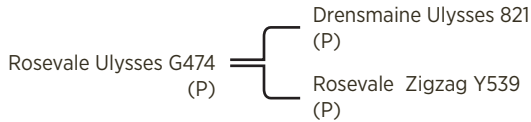

## Dam Notes

Dam DOB # Calves

## Calving Dates

Purchaser ..... \$ .....

# 67 Strathmore R314 (PS)

<b>SB Number</b>	STR20MR314	<b>Birth Date</b>	15/12/2019
<b>Fire Brand</b>	R314	<b>Classification</b>	S Bull

## Pedigree

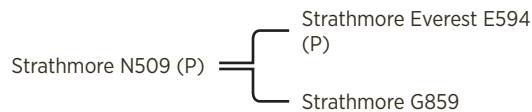
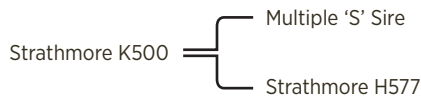

## Dam Notes

Dam DOB 5/12/2016 # Calves 3

## Calving Dates

31/01/2019, 15/12/2019, 16/10/2020

Purchaser ..... \$ .....

# 68 Strathmore R148 (PP)

<b>SB Number</b>	STR20MR148	<b>Birth Date</b>	10/10/2019
<b>Fire Brand</b>	R148	<b>Classification</b>	S Bull

## Pedigree

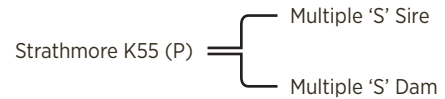
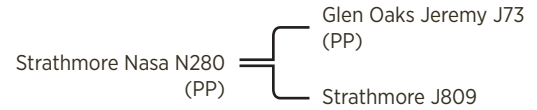

## Dam Notes

Dam DOB 30/10/2013 # Calves 5

## Calving Dates

21/11/2016, 10/12/2017, 27/11/2018, 10/10/2019, 24/10/2020

Purchaser ..... \$ .....

# 69 Strathmore R224 (PP)

<b>SB Number</b>	STR20MR224	<b>Birth Date</b>	5/11/2019
<b>Fire Brand</b>	R224	<b>Classification</b>	S Bull

## Pedigree

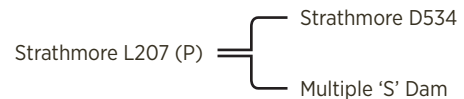
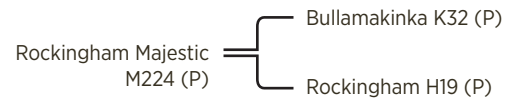

## Dam Notes

Dam DOB 19/01/2015 # Calves 4

## Calving Dates

27/09/2017, 25/11/2018, 5/11/2019, 8/11/2020

Purchaser ..... \$ .....

# 70 Strathmore R192 (PS)

<b>SB Number</b>	STR20MR192	<b>Birth Date</b>	1/01/2020
<b>Fire Brand</b>	R192	<b>Classification</b>	S Bull

## Pedigree

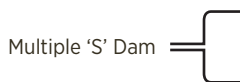
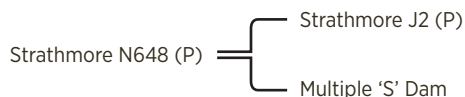

## Dam Notes

Dam DOB # Calves

## Calving Dates

Purchaser ..... \$ .....

# 71 Strathmore R180 (PS)

<b>SB Number</b>	STR20MR180	<b>Birth Date</b>	2/01/2020
<b>Fire Brand</b>	R180	<b>Classification</b>	S Bull

## Pedigree

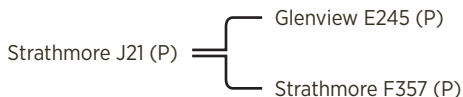
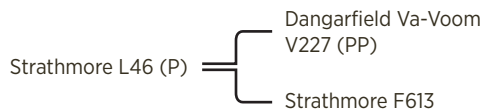

## Dam Notes

Dam DOB 18/10/2012 # Calves 6

## Calving Dates

24/11/2015, 22/11/2016, 7/12/2017, 21/11/2018, 2/01/2020, 24/11/2020

Purchaser ..... \$ .....

# 72 Strathmore R442 (P)

<b>SB Number</b>	STR20MR442	<b>Birth Date</b>	20/12/2019
<b>Fire Brand</b>	R442	<b>Classification</b>	S Bull

## Pedigree

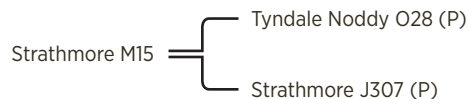
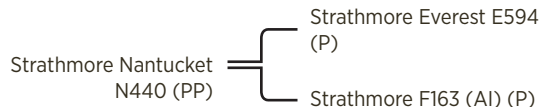

## Dam Notes

Dam DOB 14/03/2016 # Calves 3

## Calving Dates

4/06/2018, 20/12/2019, 5/12/2020

Purchaser ..... \$ .....

# 73 Strathmore R236

<b>SB Number</b>	STR20MR236	<b>Birth Date</b>	3/12/2019
<b>Fire Brand</b>	R236	<b>Classification</b>	S Bull

## Pedigree

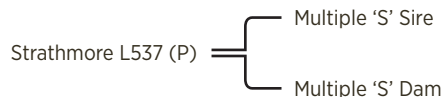
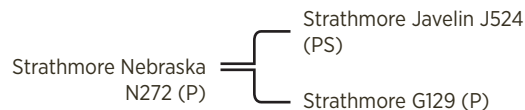

## Dam Notes

Dam DOB 1/12/2014 # Calves 4

## Calving Dates

3/11/2017, 14/10/2018, 3/12/2019, 12/11/2020

Purchaser ..... \$ .....

# 74 Strathmore R12 (P)

<b>SB Number</b>	STR20MR12	<b>Birth Date</b>	30/10/2019
<b>Fire Brand</b>	R12	<b>Classification</b>	S Bull

## Pedigree

Rowanlea Lawson L66 (P) = { Rowanlea Grandslam G36  
Rowanlea Donata D87 (P)

Multiple 'S' Dam = {

## Dam Notes

Dam DOB # Calves

## Calving Dates

Purchaser ..... \$ .....

# 75 Strathmore R322 (PP)

<b>SB Number</b>	STR20MR322	<b>Birth Date</b>	9/01/2020
<b>Fire Brand</b>	R322	<b>Classification</b>	S Bull

## Pedigree

Strathmore K500 = { Multiple 'S' Sire  
Strathmore H577

Strathmore N559 (P) = { Rosevale Ulysses G474 (P)  
Strathmore C431

## Dam Notes

Dam DOB 3/12/2016 # Calves 3

## Calving Dates

2/02/2019, 9/01/2020, 29/10/2020

Purchaser ..... \$ .....

# 76 Strathmore R664 (P)

<b>SB Number</b>	STR20MR664	<b>Birth Date</b>	14/04/2020
<b>Fire Brand</b>	R664	<b>Classification</b>	S Bull

## Pedigree

Strathmore Newton N10 (P) = { Strathmore Everest E594 (P)  
Strathmore E391

Strathmore N571 (P) = { Rosevale Ulysses G474 (P)  
Strathmore C103

## Dam Notes

Dam DOB 24/12/2016 # Calves 1

## Calving Dates

14/04/2020

Purchaser ..... \$ .....

# 77 Strathmore R334C (PS)

<b>SB Number</b>	STR20MR334C	<b>Birth Date</b>	18/01/2020
<b>Fire Brand</b>	R334	<b>Classification</b>	S Bull

## Pedigree

Strathmore Maguire M84 (PS) = { Strathmore Jungle J340 (PS)  
Strathmore J851

Strathmore L495 = { Multiple 'S' Sire  
Multiple 'S' Dam

## Dam Notes

Dam DOB 1/01/2015 # Calves 4

## Calving Dates

12/11/2017, 4/01/2019, 18/01/2020, 5/01/2021

Purchaser ..... \$ .....

# 78 Strathmore R430 (PS)

<b>SB Number</b>	STR20MR430	<b>Birth Date</b>	2/12/2019
<b>Fire Brand</b>	R430	<b>Classification</b>	S Bull

## Pedigree

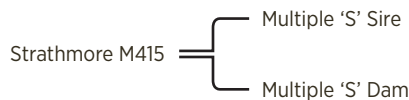
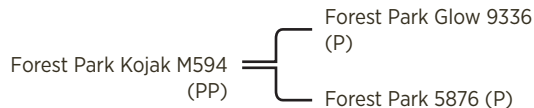

## Dam Notes

Dam DOB 16/12/2015 # Calves 3

## Calving Dates

14/11/2018, 2/12/2019, 10/11/2020

Purchaser ..... \$ .....

# 79 Strathmore R258 (PS)

<b>SB Number</b>	STR20MR258	<b>Birth Date</b>	11/02/2020
<b>Fire Brand</b>	R258	<b>Classification</b>	S Bull

## Pedigree

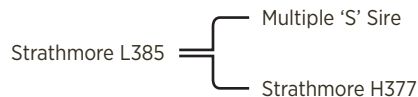
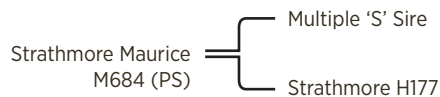

## Dam Notes

Dam DOB 28/12/2014 # Calves 4

## Calving Dates

21/10/2017, 3/11/2018, 11/02/2020, 14/01/2021

Purchaser ..... \$ .....

# 80 Strathmore R510 (P)

<b>SB Number</b>	STR20MR510	<b>Birth Date</b>	2/01/2020
<b>Fire Brand</b>	R510	<b>Classification</b>	S Bull

## Pedigree

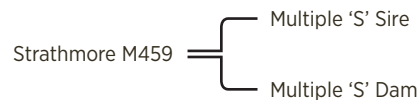
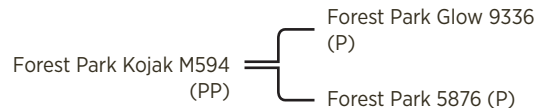

## Dam Notes

Dam DOB 4/12/2015 # Calves 3

## Calving Dates

2/12/2018, 2/01/2020, 6/12/2020

Purchaser ..... \$ .....

# 81 Strathmore R538 (P)

<b>SB Number</b>	STR20MR538	<b>Birth Date</b>	27/11/2019
<b>Fire Brand</b>	R538	<b>Classification</b>	S Bull

## Pedigree

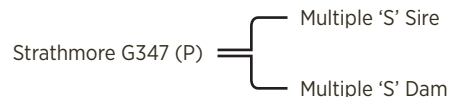
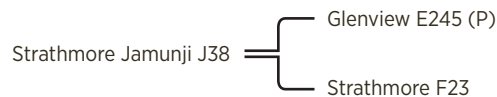

## Dam Notes

Dam DOB 1/09/2010 # Calves 7

## Calving Dates

17/11/2013, 9/02/2015, 21/01/2016, 1/01/2017, 15/12/2018, 27/11/2019, 9/11/2020

Purchaser ..... \$ .....

# 82 Strathmore R10

<b>SB Number</b>	STR20MR10	<b>Birth Date</b>	5/11/2019
<b>Fire Brand</b>	R10	<b>Classification</b>	S Bull

## Pedigree

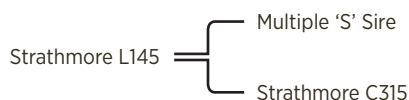
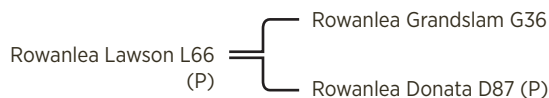

## Dam Notes

Dam DOB 2/01/2015 # Calves 4

## Calving Dates

5/12/2017, 20/11/2018, 5/11/2019, 13/11/2020

Purchaser ..... \$ .....

# 83 Strathmore R582 (PP)

<b>SB Number</b>		<b>Birth Date</b>	20/11/2019
<b>Fire Brand</b>	R582	<b>Classification</b>	Herd Bull

## Pedigree

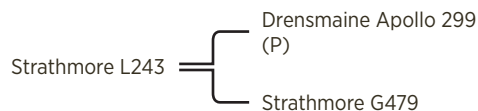
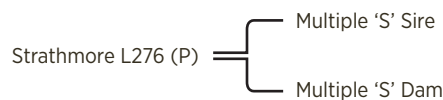

## Dam Notes

Dam DOB 2/01/2015 # Calves 4

## Calving Dates

23/10/2017, 30/10/2018, 20/11/2019, 30/11/2020

Purchaser ..... \$ .....

# 84 Strathmore R16 (PP)

<b>SB Number</b>	STR20MR16	<b>Birth Date</b>	4/11/2019
<b>Fire Brand</b>	R16	<b>Classification</b>	Herd Bull

## Pedigree

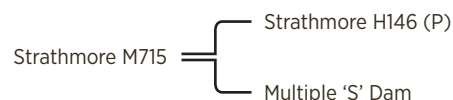
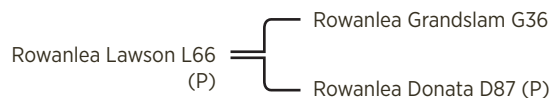

## Dam Notes

Dam DOB 3/12/2015 # Calves 3

## Calving Dates

22/09/2018, 4/11/2019, 5/01/2021

Purchaser ..... \$ .....

# 85 Strathmore R466 (PP)

<b>SB Number</b>	STR20MR466	<b>Birth Date</b>	16/11/2019
<b>Fire Brand</b>	R466	<b>Classification</b>	Herd Bull

## Pedigree

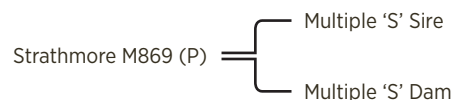
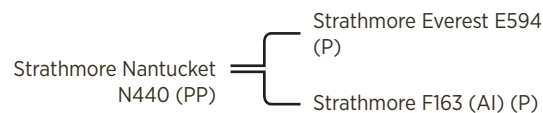

## Dam Notes

Dam DOB 30/01/2016 # Calves 3

## Calving Dates

7/12/2018, 16/11/2019, 12/05/2021

Purchaser ..... \$ .....



# 86 Strathmore R634

<b>SB Number</b>	STR20MR634	<b>Birth Date</b>	20/11/2019
<b>Fire Brand</b>	R634	<b>Classification</b>	Herd Bull

## Pedigree

Strathmore L276 (P) = { Multiple 'S' Sire  
Multiple 'S' Dam

Strathmore L249 = { Strathmore E720  
Strathmore H543

## Dam Notes

Dam DOB 20/01/2015 # Calves 4

## Calving Dates

12/10/2017, 20/10/2018, 20/11/2019, 20/11/2020

Purchaser ..... \$ .....

# 87 Strathmore R564 (P)

<b>SB Number</b>		<b>Birth Date</b>	28/10/2019
<b>Fire Brand</b>	R564	<b>Classification</b>	Herd Bull

## Pedigree

Strathmore J72 (P) = { Strathmore F306  
Strathmore F737

Strathmore J589 = { Multiple 'S' Sire  
Strathmore B183

## Dam Notes

Dam DOB 31/01/2013 # Calves 6

## Calving Dates

19/11/2015, 13/11/2016, 6/11/2017, 3/11/2018, 28/10/2019, 15/11/2020

Purchaser ..... \$ .....

# 88 Strathmore R22 (PS)

<b>SB Number</b>	STR20MR22	<b>Birth Date</b>	20/07/2019
<b>Fire Brand</b>	R22	<b>Classification</b>	Herd Bull

## Pedigree

Multiple 'S' Sire = {

Strathmore N369 (P) = { Strathmore J274 (PS)  
Multiple 'S' Dam

## Dam Notes

Dam DOB 15/12/2016 # Calves 1

## Calving Dates

20/07/2019

Purchaser ..... \$ .....

# 89 Strathmore R260 (P)

<b>SB Number</b>		<b>Birth Date</b>	6/02/2020
<b>Fire Brand</b>	R260	<b>Classification</b>	Herd Bull

## Pedigree

Strathmore Magma M786 (P) = { Rosevale Ulysses G474 (P)  
Strathmore E205

Strathmore G35 = { Multiple 'S' Sire  
Multiple 'S' Dam

## Dam Notes

Dam DOB 1/01/2011 # Calves 8

## Calving Dates

10/01/2014, 18/01/2015, 20/01/2016, 2/02/2017, 14/02/2018, 5/01/2019, 6/02/2020, 1/01/2021

Purchaser ..... \$ .....

# 90 Strathmore R398 (P)

<b>SB Number</b>		<b>Birth Date</b>	2/01/2020
<b>Fire Brand</b>	R398	<b>Classification</b>	Herd Bull

## Pedigree

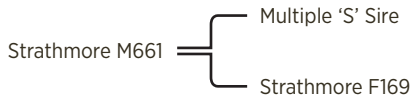
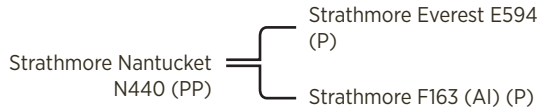

## Dam Notes

Dam DOB 28/01/2016 # Calves 3

## Calving Dates

22/11/2018, 2/01/2020, 20/12/2020

Purchaser ..... \$ .....

# 91 Strathmore R214 (PS)

<b>SB Number</b>	STR20MR214	<b>Birth Date</b>	26/10/2019
<b>Fire Brand</b>	R214	<b>Classification</b>	Herd Bull

## Pedigree

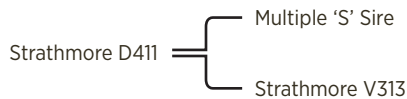
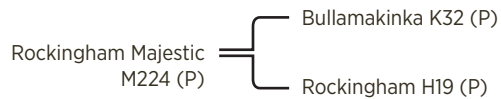

## Dam Notes

Dam DOB 27/11/2007 # Calves 10

## Calving Dates

26/11/2010, 10/10/2011, 9/12/2012, 9/12/2013, 2/12/2014, 17/12/2015, 29/11/2016, 21/11/2017, 26/10/2019

Purchaser ..... \$ .....

# 92 Strathmore R252 (P)

<b>SB Number</b>	STR20MR252	<b>Birth Date</b>	14/11/2019
<b>Fire Brand</b>	R252	<b>Classification</b>	Herd Bull

## Pedigree

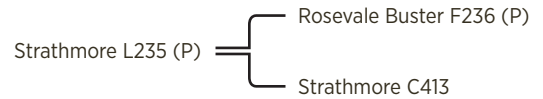
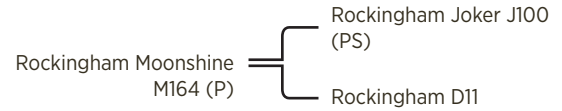

## Dam Notes

Dam DOB 20/01/2015 # Calves 4

## Calving Dates

13/09/2017, 14/10/2018, 14/11/2019, 27/10/2020

Purchaser ..... \$ .....

# 93 Strathmore R204

<b>SB Number</b>	STR20MR204	<b>Birth Date</b>	15/10/2019
<b>Fire Brand</b>	R204	<b>Classification</b>	Herd Bull

## Pedigree

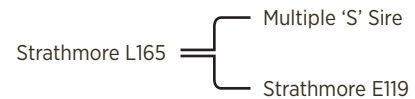
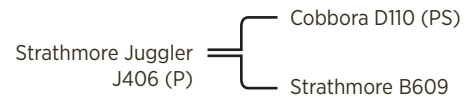

## Dam Notes

Dam DOB 17/02/2015 # Calves 4

## Calving Dates

15/12/2017, 4/11/2018, 15/10/2019, 28/12/2020

Purchaser ..... \$ .....

# 94 Strathmore R468 (PP)

<b>SB Number</b>	STR20MR468	<b>Birth Date</b>	2/12/2019
<b>Fire Brand</b>	R468	<b>Classification</b>	Herd Bull

### Pedigree

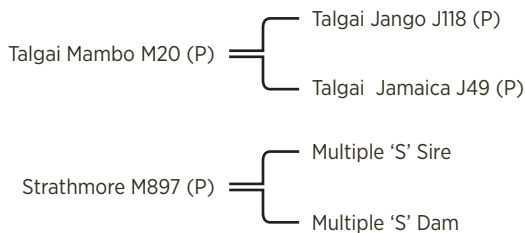

### Dam Notes

Dam DOB 30/01/2016 # Calves 3

### Calving Dates

10/12/2018, 2/12/2019, 2/11/2020

Purchaser ..... \$ .....

# 95 Strathmore R502 (PS)

<b>SB Number</b>	STR20MR502	<b>Birth Date</b>	11/09/2019
<b>Fire Brand</b>	R502	<b>Classification</b>	Herd Bull

### Pedigree

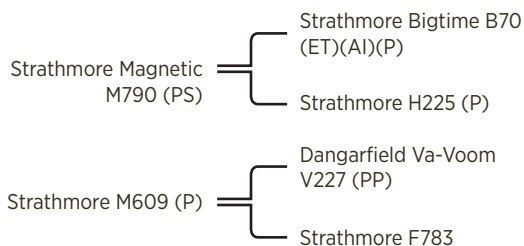

### Dam Notes

Dam DOB 22/11/2015 # Calves 2

### Calving Dates

11/09/2019, 3/12/2020

Purchaser ..... \$ .....



# 96 Strathmore R110 (PS)

<b>SB Number</b>		<b>Birth Date</b>	1/11/2019
<b>Fire Brand</b>	R110	<b>Classification</b>	Herd Bull

## Pedigree

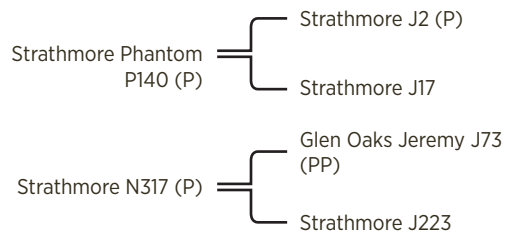

## Dam Notes

Dam DOB 15/12/2016 # Calves 1

## Calving Dates

1/11/2019

Purchaser ..... \$ .....

# 97 Strathmore R156 (P)

<b>SB Number</b>	STR20MR156	<b>Birth Date</b>	7/12/2019
<b>Fire Brand</b>	R156	<b>Classification</b>	Herd Bull

## Pedigree

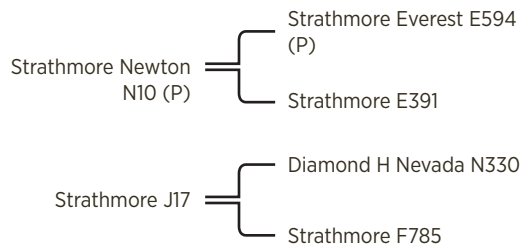

## Dam Notes

Dam DOB 15/11/2012 # Calves 6

## Calving Dates

16/12/2015, 29/12/2016, 23/11/2017, 18/01/2019,  
7/12/2019, 26/12/2020

Purchaser ..... \$ .....

# 98 Strathmore R556 (PP)

<b>SB Number</b>		<b>Birth Date</b>	7/12/2019
<b>Fire Brand</b>	R556	<b>Classification</b>	Herd Bull

## Pedigree

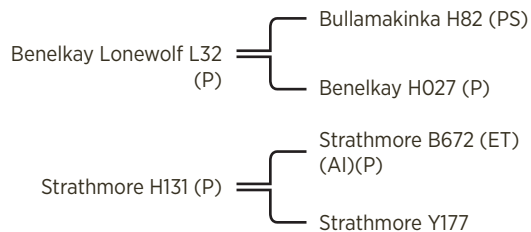

## Dam Notes

Dam DOB 14/12/2011 # Calves 8

## Calving Dates

4/12/2013, 20/12/2014, 11/12/2015, 1/12/2016, 17/12/2017,  
11/12/2018, 7/12/2019, 6/12/2020

Purchaser ..... \$ .....

# 99 Strathmore R432 (PS)

<b>SB Number</b>	STR20MR432	<b>Birth Date</b>	16/11/2019
<b>Fire Brand</b>	R432	<b>Classification</b>	Herd Bull

## Pedigree

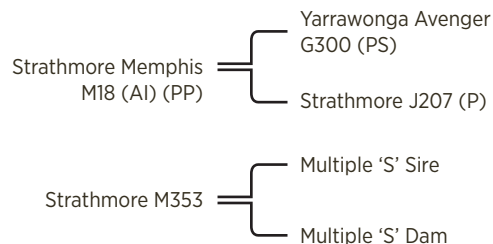

## Dam Notes

Dam DOB 27/11/2015 # Calves 3

## Calving Dates

1/01/2019, 16/11/2019, 5/12/2020

Purchaser ..... \$ .....

# 100 Strathmore R566 (PP)

<b>SB Number</b>	<b>Birth Date</b>	20/10/2019
<b>Fire Brand</b>	R566	<b>Classification</b> Herd Bull

## Pedigree

Glen Oaks Jeremy J73 (PP) = { Yarrowonga Archer G280  
Glen Oaks B73

Strathmore J15 (P) = { Strathmore F306  
Strathmore F405

## Dam Notes

Dam DOB 29/11/2012 # Calves 6

## Calving Dates

15/11/2015, 20/11/2016, 10/11/2017, 5/11/2018,  
20/10/2019, 5/11/2020

Purchaser ..... \$ .....

# 101 Strathmore R328C (P)

<b>SB Number</b>	<b>Birth Date</b>	11/01/2020
<b>Fire Brand</b>	R328	<b>Classification</b> Herd Bull

## Pedigree

Drensmaine Drifter D84 (P) = { Drensmaine Winchester  
0150 (PS)  
Drensmaine 789 (P)

Strathmore J1065 = { Multiple 'S' Sire  
Multiple 'S' Dam

## Dam Notes

Dam DOB 1/01/2013 # Calves 6

## Calving Dates

1/01/2016, 26/02/2017, 16/02/2018, 6/01/2019,  
11/01/2020, 26/12/2020

Purchaser ..... \$ .....

# 102 Strathmore R332C

<b>SB Number</b>	<b>Birth Date</b>	18/01/2020
<b>Fire Brand</b>	R332	<b>Classification</b> Herd Bull

## Pedigree

Strathmore Magnate M370 (AI) = { Yarrowonga Corvette  
H730 (P)  
Strathmore J969

Multiple 'S' Dam = {

## Dam Notes

Dam DOB # Calves

## Calving Dates

Purchaser ..... \$ .....

# 103 Strathmore R576

<b>SB Number</b>	<b>Birth Date</b>	4/12/2019
<b>Fire Brand</b>	R576	<b>Classification</b> Herd Bull

## Pedigree

Rosevale Ulysses G474 (P) = { Drensmaine Ulysses 821  
(P)  
Rosevale Zigzag Y539  
(P)

Strathmore L587 = { Multiple 'S' Sire  
Multiple 'S' Dam

## Dam Notes

Dam DOB 1/12/2014 # Calves 3

## Calving Dates

15/10/2017, 25/10/2018, 4/12/2019

Purchaser ..... \$ .....

# 104 Strathmore R240

<b>SB Number</b>	STR20MR240	<b>Birth Date</b>	7/11/2019
<b>Fire Brand</b>	R240	<b>Classification</b>	Herd Bull

## Pedigree

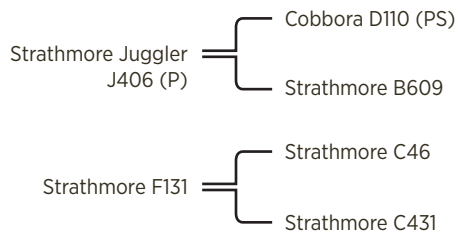

## Dam Notes

Dam DOB 16/11/2009 # Calves 9

## Calving Dates

1/12/2012, 6/11/2013, 27/10/2014, 20/11/2015, 27/11/2016, 5/11/2017, 25/11/2018, 7/11/2019, 12/11/2020

Purchaser ..... \$ .....

# 105 Strathmore R342C (PP)

<b>SB Number</b>		<b>Birth Date</b>	23/01/2020
<b>Fire Brand</b>	R342	<b>Classification</b>	Herd Bull

## Pedigree

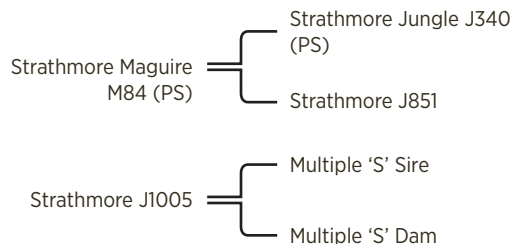

## Dam Notes

Dam DOB 1/01/2013 # Calves 5

## Calving Dates

22/11/2015, 25/11/2016, 23/11/2017, 15/11/2018, 23/01/2020

Purchaser ..... \$ .....

# 106 Strathmore R228 (PP)

<b>SB Number</b>	STR20MR228	<b>Birth Date</b>	14/11/2019
<b>Fire Brand</b>	R228	<b>Classification</b>	Herd Bull

## Pedigree

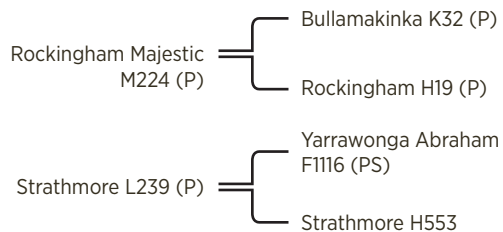

## Dam Notes

Dam DOB 22/12/2014 # Calves 4

## Calving Dates

9/11/2017, 2/11/2018, 14/11/2019, 2/02/2021

Purchaser ..... \$ .....

# 107 Strathmore R604

<b>SB Number</b>		<b>Birth Date</b>	7/12/2019
<b>Fire Brand</b>	R604	<b>Classification</b>	Herd Bull

## Pedigree

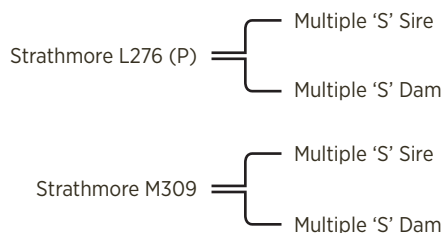

## Dam Notes

Dam DOB 11/01/2016 # Calves 2

## Calving Dates

25/11/2018, 7/12/2019

Purchaser ..... \$ .....

# 108 Strathmore R636 (PP)

<b>SB Number</b>	STR20MR636	<b>Birth Date</b>	20/12/2019
<b>Fire Brand</b>	R636	<b>Classification</b>	Herd Bull

## Pedigree

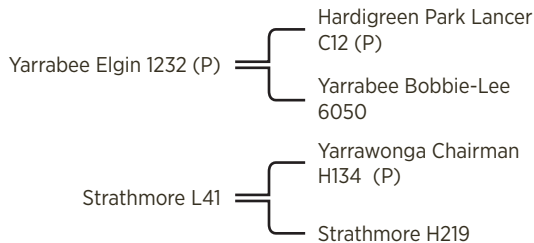

## Dam Notes

Dam DOB 22/12/2014 # Calves 4

## Calving Dates

11/12/2017, 18/12/2018, 20/12/2019, 10/12/2020

Purchaser ..... \$ .....

# 109 Strathmore R138

<b>SB Number</b>	STR20MR138	<b>Birth Date</b>	5/12/2019
<b>Fire Brand</b>	R138	<b>Classification</b>	Herd Bull

## Pedigree

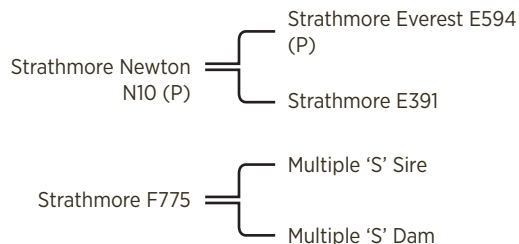

## Dam Notes

Dam DOB 1/12/2009 # Calves 8

## Calving Dates

20/01/2012, 2/12/2012, 6/01/2014, 28/01/2016, 31/12/2016, 13/11/2017, 5/12/2019, 2/02/2021

Purchaser ..... \$ .....

# 110 Strathmore R278 (PP)

<b>SB Number</b>		<b>Birth Date</b>	4/02/2020
<b>Fire Brand</b>	R278	<b>Classification</b>	Herd Bull

## Pedigree

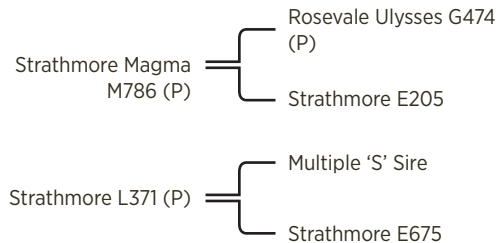

## Dam Notes

Dam DOB 28/01/2015 # Calves 4

## Calving Dates

12/02/2018, 1/01/2019, 4/02/2020, 1/01/2021

Purchaser ..... \$ .....

# 111 Strathmore R88

<b>SB Number</b>		<b>Birth Date</b>	9/12/2019
<b>Fire Brand</b>	R88	<b>Classification</b>	Herd Bull

## Pedigree

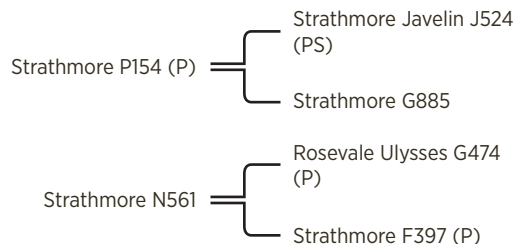

## Dam Notes

Dam DOB 1/12/2016 # Calves 2

## Calving Dates

9/12/2019, 10/11/2020

Purchaser ..... \$ .....

# 112 Strathmore R352 (P)

<b>SB Number</b>	STR20MR352	<b>Birth Date</b>	15/11/2019
<b>Fire Brand</b>	R352	<b>Classification</b>	Herd Bull

## Pedigree

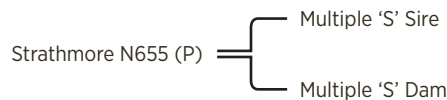
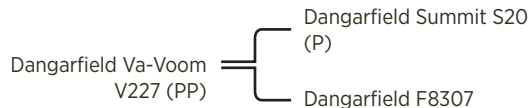

## Dam Notes

Dam DOB	11/11/2016	# Calves	2
---------	------------	----------	---

## Calving Dates

15/11/2019, 15/11/2020

Purchaser ..... \$ .....

# 113 Strathmore R172 (PP)

<b>SB Number</b>	STR20MR172	<b>Birth Date</b>	20/11/2019
<b>Fire Brand</b>	R172	<b>Classification</b>	Herd Bull

## Pedigree

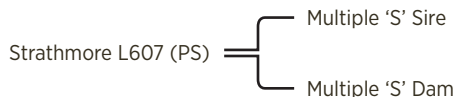
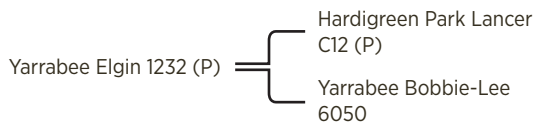

## Dam Notes

Dam DOB	1/12/2015	# Calves	3
---------	-----------	----------	---

## Calving Dates

15/11/2018, 20/11/2019, 2/12/2020

Purchaser ..... \$ .....

# 114 Strathmore R360 (PP)

<b>SB Number</b>	STR20MR360	<b>Birth Date</b>	2/09/2019
<b>Fire Brand</b>	R360	<b>Classification</b>	Herd Bull

## Pedigree

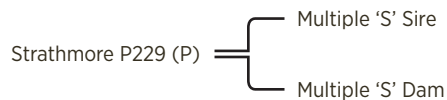

## Dam Notes

Dam DOB	21/11/2017	# Calves	2
---------	------------	----------	---

## Calving Dates

2/09/2019, 13/11/2020

Purchaser ..... \$ .....

# 115 Strathmore R482 (P)

<b>SB Number</b>	STR20MR482	<b>Birth Date</b>	3/01/2020
<b>Fire Brand</b>	R482	<b>Classification</b>	Herd Bull

## Pedigree

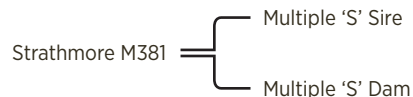
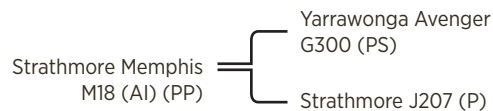

## Dam Notes

Dam DOB	26/11/2015	# Calves	3
---------	------------	----------	---

## Calving Dates

8/02/2019, 3/01/2020, 14/12/2020

Purchaser ..... \$ .....



# 116 Strathmore R534 (P)

<b>SB Number</b>		<b>Birth Date</b>	6/12/2019
<b>Fire Brand</b>	R534	<b>Classification</b>	Herd Bull

## Pedigree

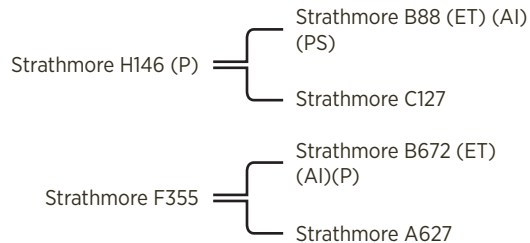

## Dam Notes

Dam DOB 20/11/2009 # Calves 8

## Calving Dates

18/03/2012, 15/01/2014, 12/11/2015, 30/11/2016,  
18/11/2017, 12/11/2018, 6/12/2019, 2/11/2020

Purchaser ..... \$ .....

# 117 Strathmore R364 (PS)

<b>SB Number</b>	STR20MR364	<b>Birth Date</b>	29/08/2019
<b>Fire Brand</b>	R364	<b>Classification</b>	Herd Bull

## Pedigree

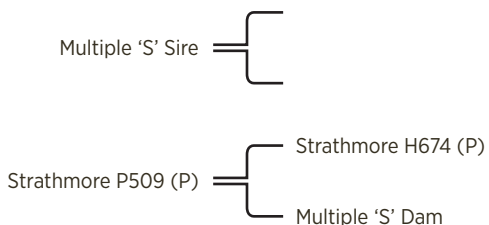

## Dam Notes

Dam DOB 9/11/2017 # Calves 2

## Calving Dates

29/08/2019, 29/10/2020

Purchaser ..... \$ .....

# 118 Strathmore R600

<b>SB Number</b>		<b>Birth Date</b>	6/12/2019
<b>Fire Brand</b>	R600	<b>Classification</b>	Herd Bull

## Pedigree

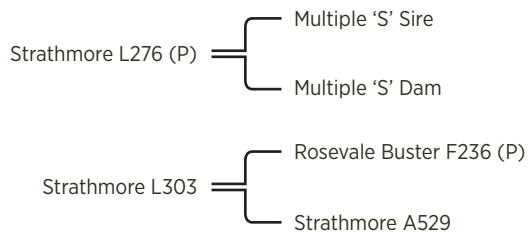

## Dam Notes

Dam DOB 29/01/2015 # Calves 3

## Calving Dates

20/11/2017, 25/11/2018, 6/12/2019

Purchaser ..... \$ .....

# 119 Strathmore R336 (PS)

<b>SB Number</b>	STR20MR336	<b>Birth Date</b>	13/10/2019
<b>Fire Brand</b>	R336	<b>Classification</b>	Herd Bull

## Pedigree

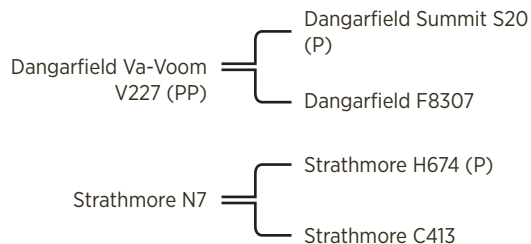

## Dam Notes

Dam DOB 29/11/2016 # Calves 2

## Calving Dates

13/10/2019, 20/10/2020

Purchaser ..... \$ .....

# 120 Strathmore R136 (PP)

<b>SB Number</b>	STR20MR136	<b>Birth Date</b>	30/10/2019
<b>Fire Brand</b>	R136	<b>Classification</b>	S Bull

## Pedigree

Strathmore Nasa N280 (PP) = { Glen Oaks Jeremy J73 (PP)  
Strathmore J809

Strathmore K213 (P) = { Multiple 'S' Sire  
Strathmore A73 (P)

## Dam Notes

Dam DOB 1/12/2013 # Calves 5

## Calving Dates

1/01/2017, 15/12/2017, 20/11/2018, 30/10/2019, 9/10/2020

Purchaser ..... \$ .....

# 121 Strathmore R464 (PS)

<b>SB Number</b>	STR20MR464	<b>Birth Date</b>	10/11/2019
<b>Fire Brand</b>	R464	<b>Classification</b>	Herd Bull

## Pedigree

Strathmore Nantucket N440 (PP) = { Strathmore Everest E594 (P)  
Strathmore F163 (AI) (P)

Strathmore M105 = { Multiple 'S' Sire  
Strathmore F613

## Dam Notes

Dam DOB 2/01/2016 # Calves 3

## Calving Dates

26/11/2018, 10/11/2019, 1/11/2020

Purchaser ..... \$ .....

# 122 Strathmore R366 (PP)

<b>SB Number</b>	STR20MR366	<b>Birth Date</b>	15/02/2020
<b>Fire Brand</b>	R366	<b>Classification</b>	Herd Bull

## Pedigree

Strathmore Moe M766 (P) = { Strathmore Bigtime B70 (ET)(AI)(P)  
Strathmore E213

Strathmore N627 (P) = { Multiple 'S' Sire  
Multiple 'S' Dam

## Dam Notes

Dam DOB 30/11/2016 # Calves 3

## Calving Dates

1/01/2019, 15/02/2020, 5/01/2021

Purchaser ..... \$ .....

# 123 Strathmore R216 (P)

<b>SB Number</b>	STR20MR216	<b>Birth Date</b>	30/10/2019
<b>Fire Brand</b>	R216	<b>Classification</b>	Herd Bull

## Pedigree

Strathmore Juggler J406 (P) = { Cobbora D110 (PS)  
Strathmore B609

Strathmore L163 (P) = { Strathmore F528 (P)  
Strathmore C165

## Dam Notes

Dam DOB 28/11/2014 # Calves 4

## Calving Dates

23/10/2017, 21/10/2018, 30/10/2019, 1/10/2020

Purchaser ..... \$ .....

# 124 Strathmore R26 (P)

<b>SB Number</b>	STR20MR26	<b>Birth Date</b>	30/10/2019
<b>Fire Brand</b>	R26	<b>Classification</b>	Herd Bull

## Pedigree

Glenview M85 (P) = { Waco Eland J1402 (P)  
Multiple 'S' Dam

Strathmore N485 (P) = { Multiple 'S' Sire  
Multiple 'S' Dam

## Dam Notes

Dam DOB 16/12/2016 # Calves 3

## Calving Dates

19/12/2018, 30/10/2019, 10/01/2021

Purchaser ..... \$ .....

# 125 Strathmore R406 (PS)

<b>SB Number</b>	STR20MR406	<b>Birth Date</b>	5/02/2020
<b>Fire Brand</b>	R406	<b>Classification</b>	Herd Bull

## Pedigree

Strathmore Nantucket N440 (PP) = { Strathmore Everest E594 (P)  
Strathmore F163 (AI) (P)

Strathmore M89 = { Warena Sahara S200 (P)  
Strathmore J337 (P)

## Dam Notes

Dam DOB 21/12/2015 # Calves 3

## Calving Dates

26/01/2019, 5/02/2020, 18/02/2021

Purchaser ..... \$ .....

# 126 Strathmore R606 (PS)

<b>SB Number</b>		<b>Birth Date</b>	11/11/2019
<b>Fire Brand</b>	R606	<b>Classification</b>	Herd Bull

## Pedigree

Strathmore K314 = { Multiple 'S' Sire  
Strathmore G59

Strathmore K25 (P) = { Strathmore B672 (ET) (AI)(P)  
Strathmore H109

## Dam Notes

Dam DOB 29/11/2013 # Calves 3

## Calving Dates

30/01/2018, 11/11/2019, 17/11/2020

Purchaser ..... \$ .....

# 127 Strathmore R4 (P)

<b>SB Number</b>		<b>Birth Date</b>	19/10/2019
<b>Fire Brand</b>	R4	<b>Classification</b>	Herd Bull

## Pedigree

Rowanlea Lawson L66 (P) = { Rowanlea Grandslam G36  
Rowanlea Donata D87 (P)

Strathmore L315 = { Multiple 'S' Sire  
Strathmore E323 (P)

## Dam Notes

Dam DOB 3/05/2015 # Calves 4

## Calving Dates

25/09/2017, 20/01/2019, 25/02/2020, 5/02/2021

Purchaser ..... \$ .....

# 128 Strathmore R270 (P)

<b>SB Number</b>	<b>Birth Date</b>	25/01/2020
<b>Fire Brand</b>	R270	<b>Classification</b> Herd Bull

## Pedigree

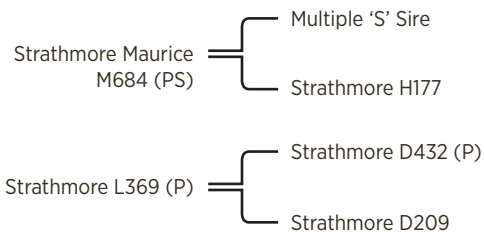

## Dam Notes

Dam DOB 28/03/2015 # Calves 4

## Calving Dates

9/10/2017, 31/10/2018, 25/01/2020, 7/01/2021

Purchaser ..... \$ .....

# 129 Strathmore R120 (P)

<b>SB Number</b>	<b>Birth Date</b>	1/01/2020
<b>Fire Brand</b>	R120	<b>Classification</b> Herd Bull

## Pedigree

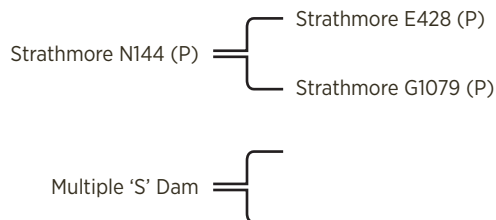

## Dam Notes

Dam DOB # Calves

## Calving Dates

Purchaser ..... \$ .....

# 130 Strathmore R356 (P)

<b>SB Number</b>	STR20MR356	<b>Birth Date</b>	15/10/2019
<b>Fire Brand</b>	R356	<b>Classification</b>	Herd Bull

## Pedigree

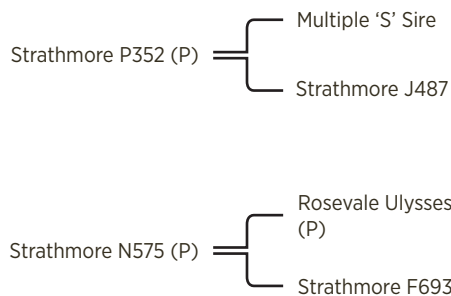

## Dam Notes

Dam DOB 30/12/2016 # Calves 1

## Calving Dates

15/10/2019

Purchaser ..... \$ .....





# Notes

---

---

---

---

---

---

---

---

---

---

---

---

---

---

---

---

---

---

---

---

---

---

---

---

---



# Notes

---

---

---

---

---

---

---

---

---

---

---

---

---

---

---

---

---

---

---

---

---

---

---

---

---

---

# Notes

---

---

---

---

---

---

---

---

---

---

---

---

---

---

---

---

---

---

---

---

---

---

---

---

# Notes

---

---

---

---

---

---

---

---

---

---

---

---

---

---

---

---

---

---

---

---

---

---

---



# Notes

---

---

---

---

---

---

---

---

---

---

---

---

---

---

---

---

---

---

---

---

---

---

---

---



# Notes

---

---

---

---

---

---

---

---

---

---

---

---

---

---

---

---

---

---

---

---

---

---

---

---

# Buyer's Instruction Slip

**Strathmore Sale 19th October 2021**

No Verbal Instructions can be accepted.

Name

Address line 1

Address line 2

Postcode

Stud No.

Telephone

Account to

Lots purchased

Total No.

Motor Transports required

Insure for (state period)

Is a stud transfer required? Yes / No

If 'Yes' please state name to be transferred to

Stud No.

Any further instructions

Signature

Date

/   /

